



GALVANISED T-BLADE POST SUPPORTS

JUN23

Compliant with the requirements of AS1720.

G GALVANISED

BOLTED TO CONCRETE

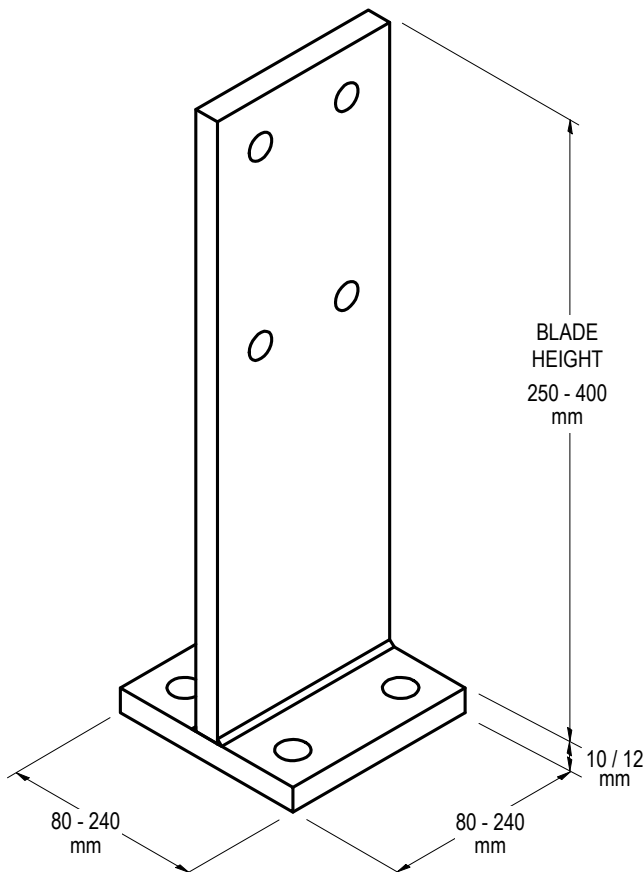
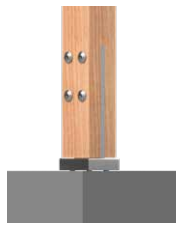

APPLICATION

VUETRADE Galvanised T-Blade Post Supports are used as a concealed post support on large decorative posts. Its 10 / 12 mm steel thickness throughout the product offers a strong, solid connection to be bolted down onto a concrete base.

SPECIFICATION

VUETRADE Galvanised T-Blade Post Supports are manufactured in 10 or 12mm steel and corrosion protected with Hot Dipped Galvanised as per AS/NZS 4680:2006.

FASTENERS

Saddle: 4x Zinc-Nickel Coated VUEBOLT or appropriate M12 / M16 / M20 bolts with hex nuts*

Base: 4x M12 / M16 / M20 concrete bolts or equivalent*

* Based on product size.

PRODUCT SIZES

Table 1: T-Blade Product Sizes

Product Code	Blade Height (mm)	Base Size (mm x mm)	Post Size Suitability (mm)	Bolt Size	Thickness (mm)
VBPTB 90100	250	80 x 80	90 - 100	M12	10
VBPTB 115140	275	110 x 110	115 - 140	M16	10
VBPTB 150180	300	140 x 140	150 - 180	M16	10
VBPTB 180200	350	180 x 180	180 - 250	M16	10
VBPTB 250350	400	240 x 240	250 - 350	M20	12

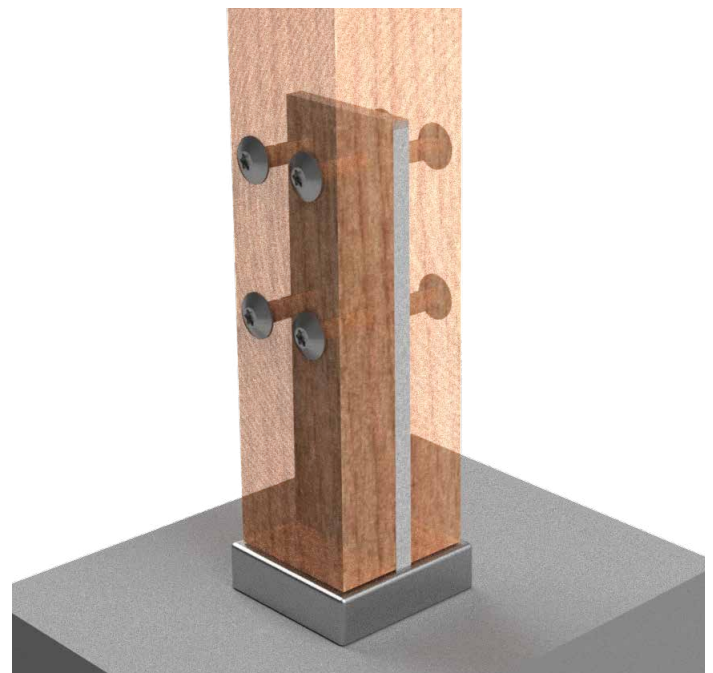



GALVANISED T-BLADE POST SUPPORTS

JUN23

INSTALLATION GUIDE AND BOLT FIXING SCHEDULE

Cut a 10mm or 12mm slit in the middle of timber to hide concrete bolts (see note 1)

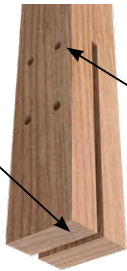

Drill appropriate Ø holes in timber to fit bolts as defined in Table 1.

Install 4x appropriate sized concrete bolts or equivalent to ground

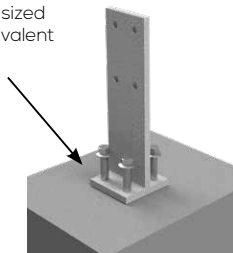

Place a T-Blade cap to hide concrete bolts (see note 2)

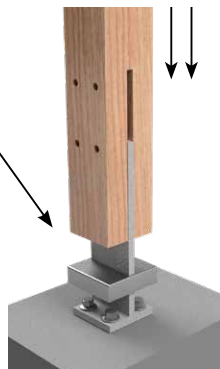

Slide timber to T-Blade

Install 4x VUEBOLT or appropriate bolts fastened with hex nuts

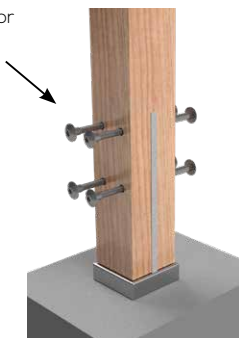

NOTES:

- VUETRADE has prepared a comprehensive cutting schedule for all sizes of T-Blade Post Supports containing precise cutting and drilling measurements. Refer to the VUETRADE website for cutting schedule.
- T-Blade cap sold separately, VUETRADE recommends fitting T-Blade caps on the T-Blade Post Support for a concealed finish.
- VUEBOLT may be used as an alternative to standard bolts when fixing post support to timber posts for a concealed and smooth finish.

DESIGN CAPACITY DATA

Table 2: Design capacity of T-Blade Post Support fixed with 4x bolts on various timber joint groups

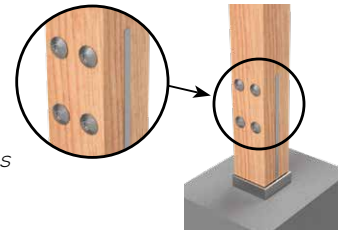

Joint Group	J3	J4	J5	JD3	JD4	JD5
M12 Bolt	47.4	37.7	32.6	57.0	47.4	41.4
M16 Bolt	57.0	57.0	57.0	57.0	57.0	57.0
M20 Bolt	57.0	57.0	57.0	57.0	57.0	57.0

Table 3: Design capacity of T-Blade Post Support fixed with 2x bolts on various timber joint groups

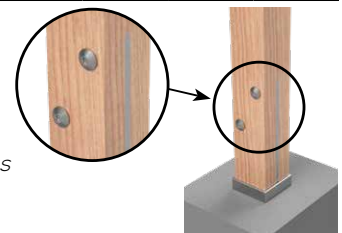

Joint Group	J3	J4	J5	JD3	JD4	JD5
M12 Bolt	23.7	18.8	16.3	29.5	23.7	20.7
M16 Bolt	42.3	33.3	28.8	52.3	42.3	36.7
M20 Bolt	57.0	50.8	42.4	57.0	57.0	57.0

NOTES:

- Design capacities in the above tables may be limited by the withdrawal tensile capacity of concrete bolts used to fasten T-Blade to concrete ground. Ensure that suitable concrete bolts are used for above design capacity to be valid, otherwise reduce design capacities appropriately.
- The design capacity of galvanised T-Blade is capped at 57kN.
- Modification factors k_1 for different load cases are adopted from AS1720.1-2010.
- Design capacities in the above tables are based on Category 1 joints where it is applicable for failures that would be unlikely to affect an area of greater than 25m². For Category 2 and Category 3 joints, design capacities from the table are multiplied by 0.941 and 0.882 respectively.
- VUETRADE Post Supports should only be used to resist wind uplift / dead load as specified in the TDS and should not be assumed to provide lateral stability. Sufficient bracing should be provided and approved by a structural engineer for lateral stability.
- Two bolts may be used instead of four, however strength verification must be conducted by a structural engineer to ensure that the two bolt usage is acceptable.
- If fixing using two bolts, bolts should be fixed using non-adjacent bolt holes (use holes diagonally as shown in figure above).

