

# TIMBER CONNECTORS PRODUCT GUIDE

Innovative, timesaving, quality timber connectors designed by builders for builders.



G pg 10

G pg 6



FRAMING CONNECTORS

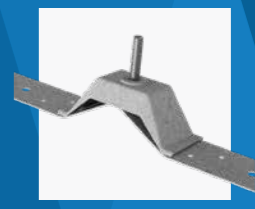

BRACING & TENSIONERS



POST SUPPORTS

G pg 30



VUEBOLT

ZN pg 37



MASONRY TIES AND VENTS

G pg 24



BUILDING BRACKETS

G pg 18

### Category Contents

- Bracing & Tensioners..... 6
- Framing Connectors ..... 10
- Building Brackets ..... 18
- Post Supports ..... 30
- Ant Caps ..... 24
- Masonry Ties ..... 24
- Vents..... 24
- VUEBOLT ..... 37

### Cyclonic Range ..... 40



### CoastalSS ..... 42



### BLACKOUT ..... 45



# OUR DIFFERENCE

**VUETRADE is the first choice for tradespeople, ahead of the crowd with innovative, timesaving, quality timber connectors.**

Using this guide, you can locate your required connections and make initial comparisons between different products for your timber framing project.

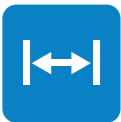

**Size Ranges:**  
To suit the Australian market.



**Materials:**  
Galvanised, 304 and 316 Stainless Steel, BLACKOUT Powder Coated.



**Australian Made:**  
Where marked by the green and gold kangaroo.

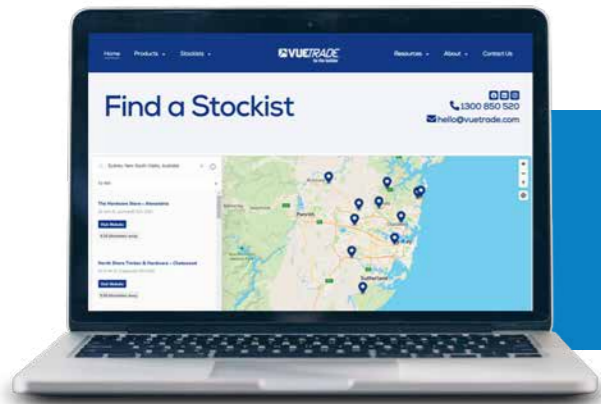

**vuetrade.com**

Full product range, technical data, installation videos and further contact.

Take a look at our website for further information on any of our connectors.

# SPECIFICATION AREA CHART

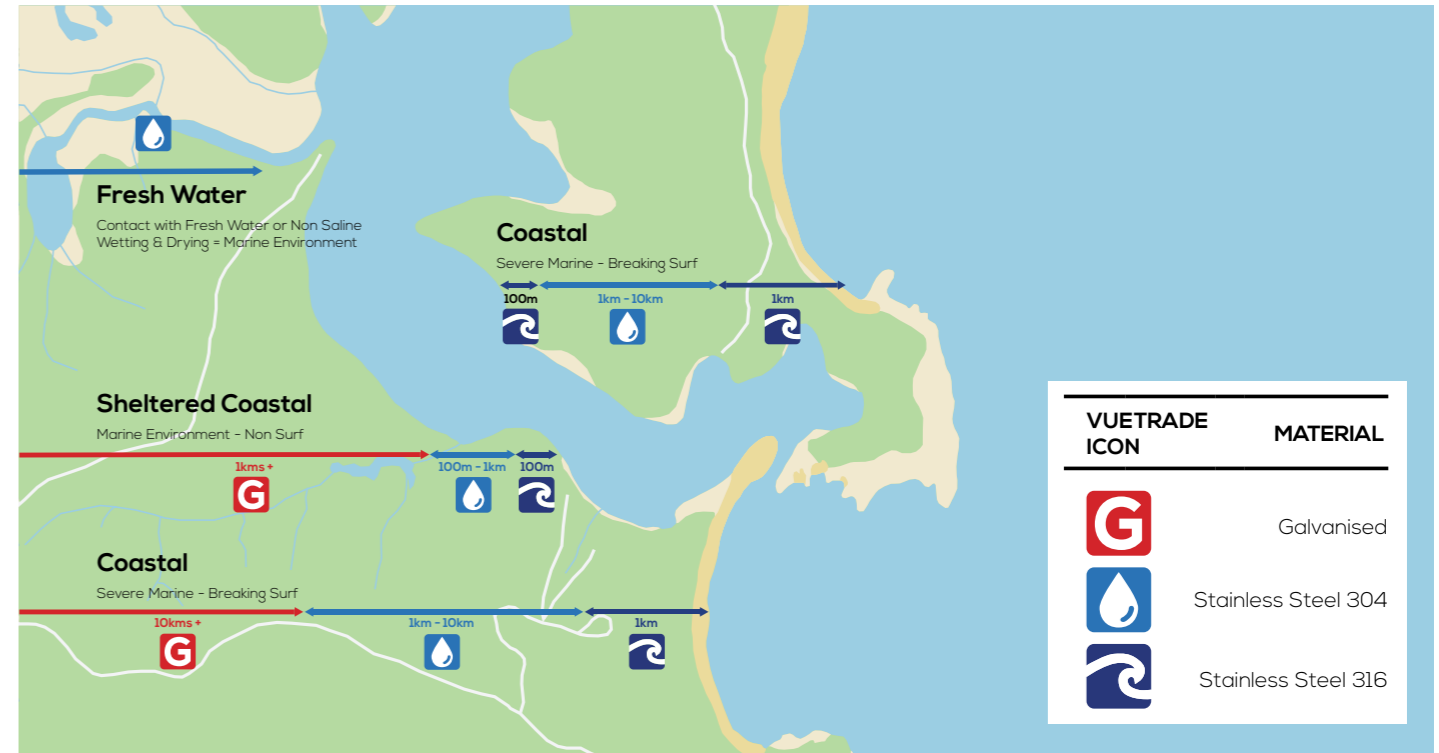

## The right material for your location.

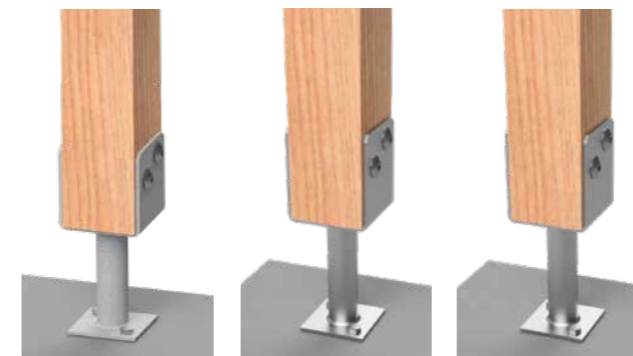

**G GALVANISED**   **304 STAINLESS STEEL**   **316 STAINLESS STEEL**

When using any timber connector externally it is vital to understand the location and environment and why this should affect your choice of post support and/or material.



### STANDARD / GALVANISED

- Internal / enclosed
- Exterior/exposed inland areas except if in contact with fresh water or non-saline wetting & drying



### MARINE ENVIRONMENT

- Marine Environment - 100m up to 1km from a non-surf coast and from 1km up to 10km from a surf coast
- External applications in contact with freshwater or subject to non-saline wetting and drying
- Minimum steel grade required Stainless Steel 304



### SEVERE MARINE

- Severe Marine - 100m from a non-surf coast and up to 1km from a surf coast
- Minimum Steel Grade Stainless Steel 316
- No 'Tea Staining', a superficial 'rust' look that occurs on lower grades of Stainless Steel including 304.



# BRACING & TENSIONING

-   
VUESMART  
pg 8
-   
Punched Strapping  
pg 8
-   
Light Duty Strapping  
pg 9
-   
Unpunched Strapping  
pg 9
-   
Angle Mini Brace  
pg 9
-   
Speed Brace  
pg 9
-   
Punched Strapping Strips  
pg 8

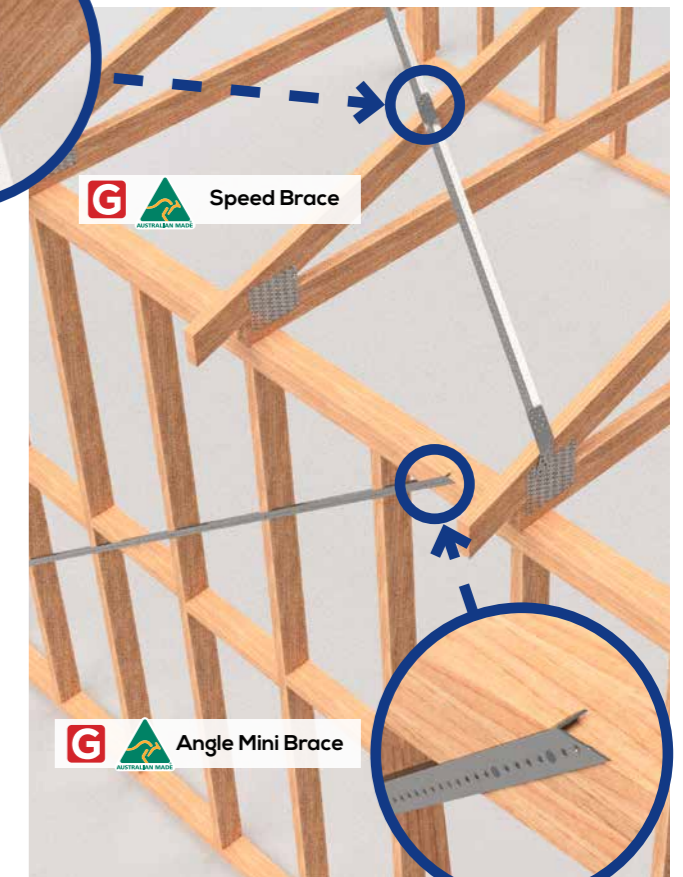
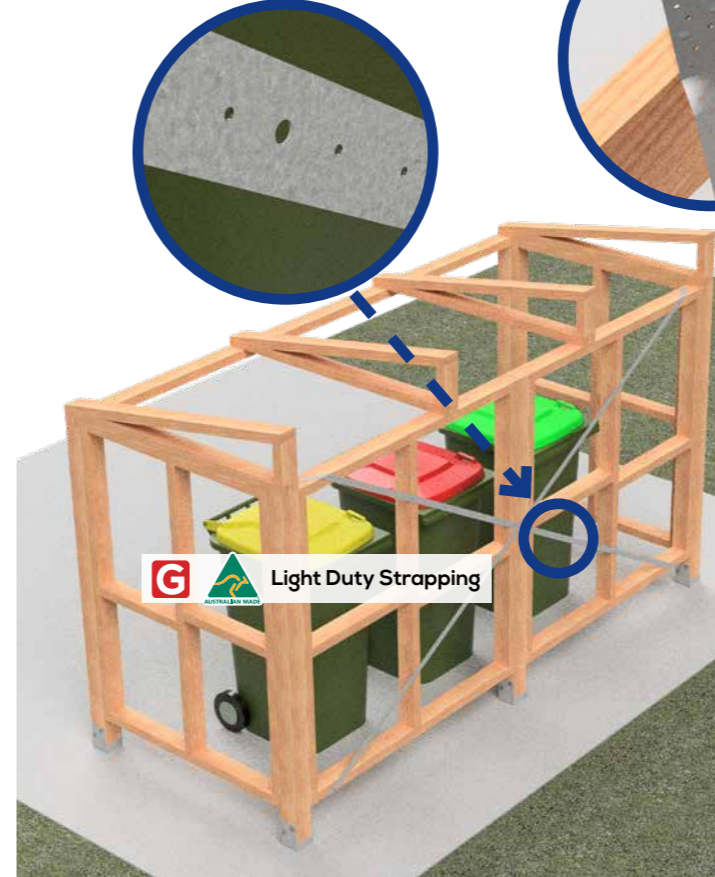
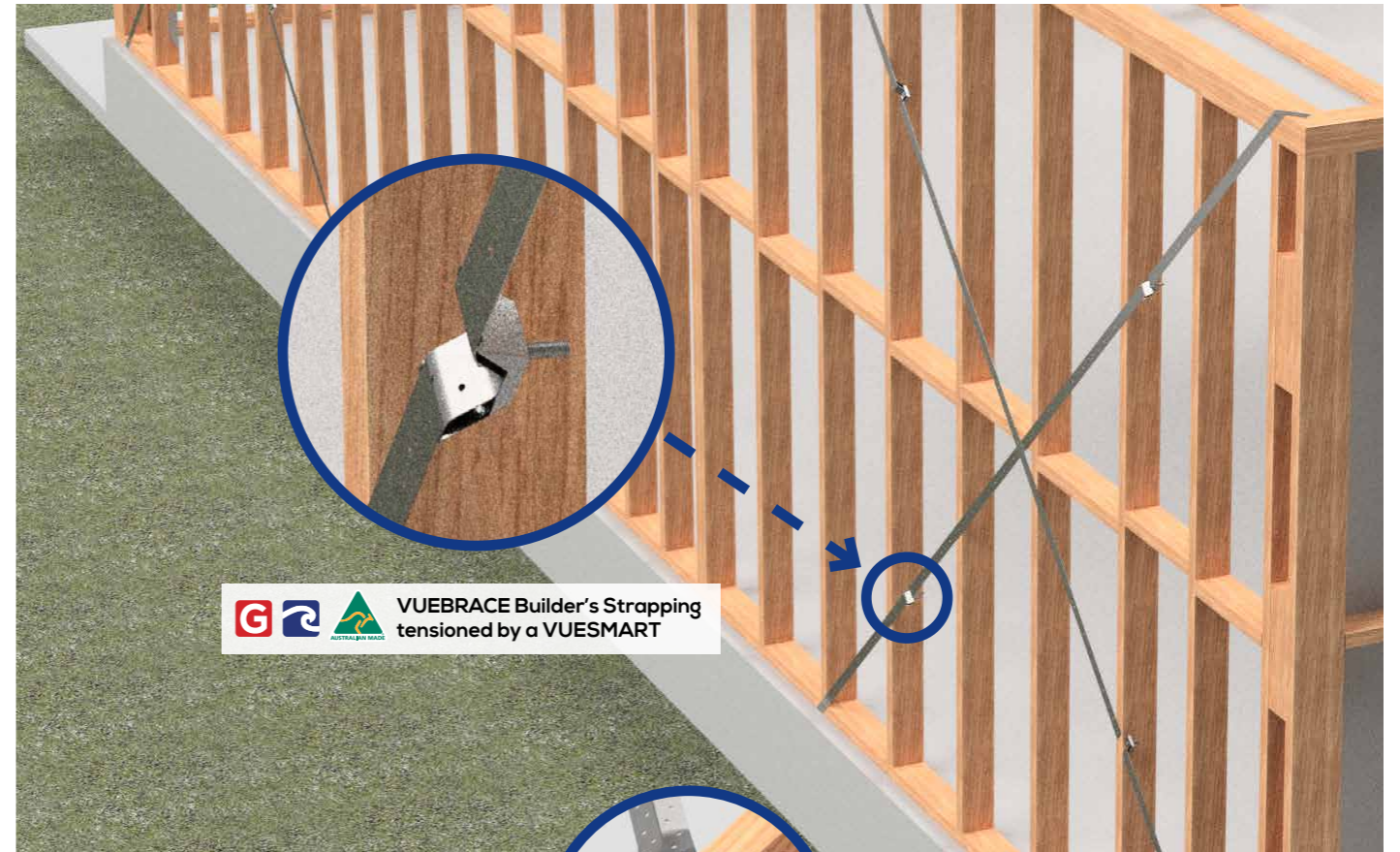

# BRACING & TENSIONING

## VUESMART Tensioner

Order Page: 47

**Two-part system with Cup and Bolt**  
- The first and original design to tension strapping using power tools

**5/16 Hex Head Driver Bit included in every Six Pack**  
- Otherwise use regular cross-head to tighten

**Locally made in Australia**  
- Support Australian employment and keep the economy rolling



Product Code: VUESMART

Compliant with the requirements of AS1684.

Available in Galvanised.

## Light Duty Strapping

Order Page: 48



**25x0.6mm and 25x0.8mm**

- Two sizes to suit your project needs, available in coils lengths of 6.0m, 15.0m and 30.0m

**Non-structural applications**

- Cost effective solution for no heavy load and minimal wind uplift scenarios

**Repeated punched pattern**

- Use VUESMART tensioner and 30x2.8mm nails conveniently

Product Code: VB25

Suitable for light duty non-structural applications.

Available in Galvanised.

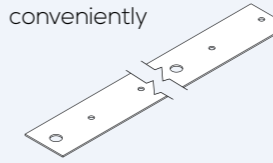

## Unpunched Strapping

Order Page: 49



**Flat undisturbed surface**  
- Better aesthetic finish for locations where the bracing would be exposed, widely used in pre-fab markets

**30m and 50m lengths**  
- Long coils for large projects in either 0.8mm and 1.0mm thickness

**Higher tensile capacity compared to punched strapping**

- Great for general use projects where higher load ratings are required

Product Code: VB-UP

Compliant with the requirements of AS1684 for non-bracing applications.

Available in Galvanised.

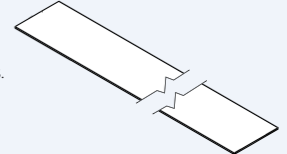

## Punched Builder's Strapping

**6m, 15m, 30m & 50m coils**  
- Useful lengths ideal for different projects

**0.8, 1.0 & 1.2mm thickness**  
- Stronger tension capacities as required to suit the frame requirements.

**Galvanised & Stainless Steel 316**  
- Use the most suitable material for your project environment



Also available in 3.15, 3.6 & 4.2m strips

Order Page: 48 / 82



Product Code: VB

Compliant with the requirements of AS1684 and NCC2022.



Available in Galvanised and Stainless Steel.

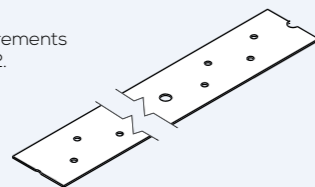

Galvanised & Stainless Steel 316



## Angle Mini Brace

Order Page: 50

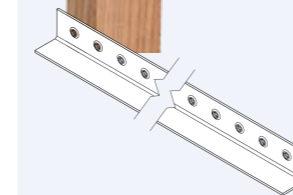

**Holes Pre-Punched**

- Simply nail in appropriate holes to secure to timber frame.

**3.6m, 4.2m & 4.8m lengths**

- Most common sizes for residential and light commercial timber frame walls.

**18 x 16 x 1.2mm**

- Compliant to Australian standards.

Product Code: ABMN

Compliant with the requirements of AS1684 and NCC2022.

Available in Galvanised.

## Speed Brace

Order Page: 50

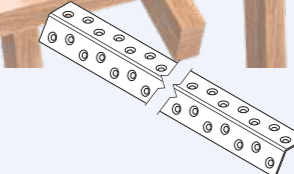

**Manufactured to AS4440-2004**

- Compliant and durable solution to bracing nail-plated timber roof trusses

Product Code: SPEED

Compliant with the requirements of AS1684 and AS4440.

Available in Galvanised.

**4.0m, 5.0m & 6.0m lengths**

- To suit your truss design with minimal waste



# FRAMING CONNECTORS

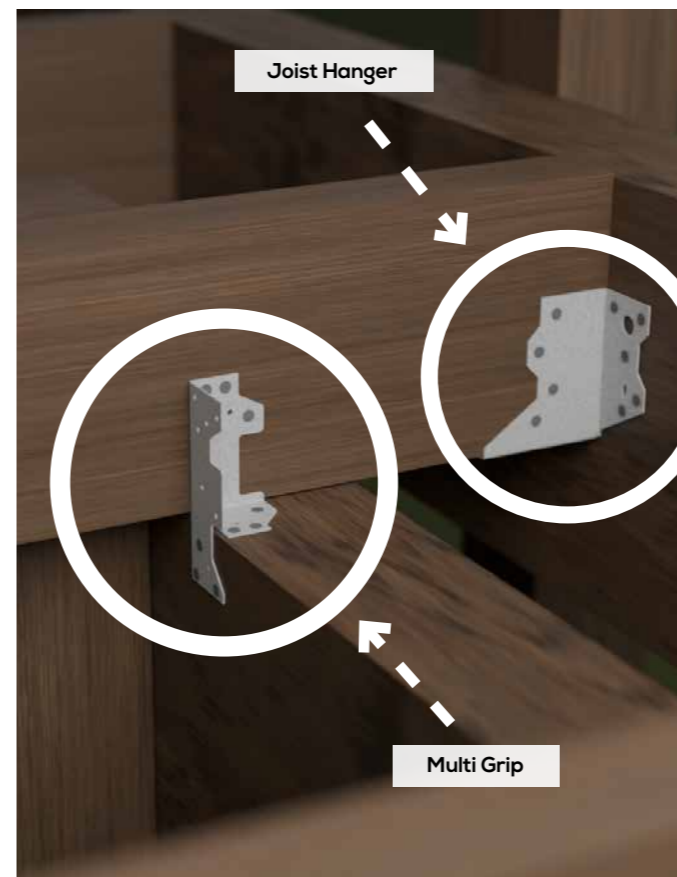
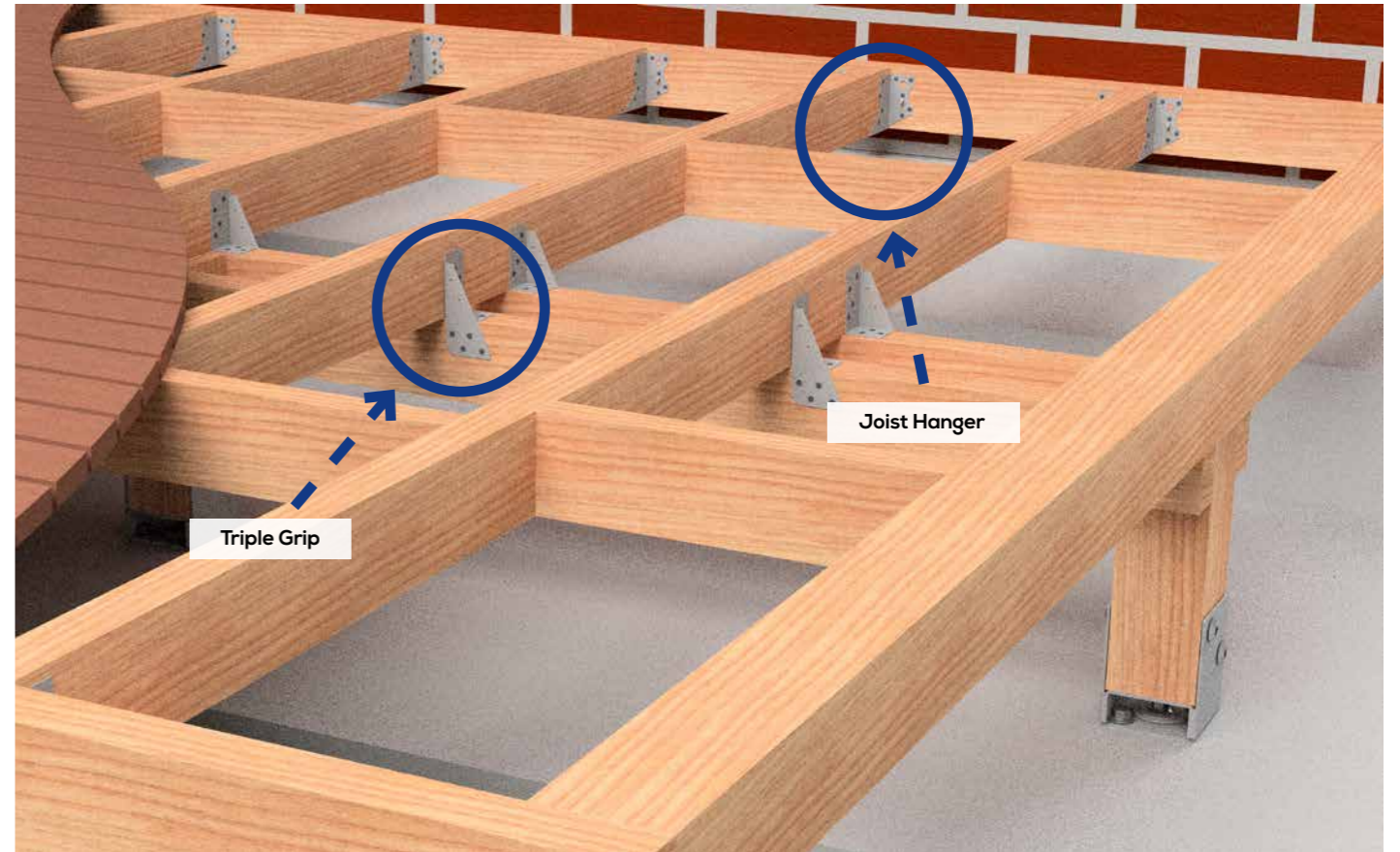
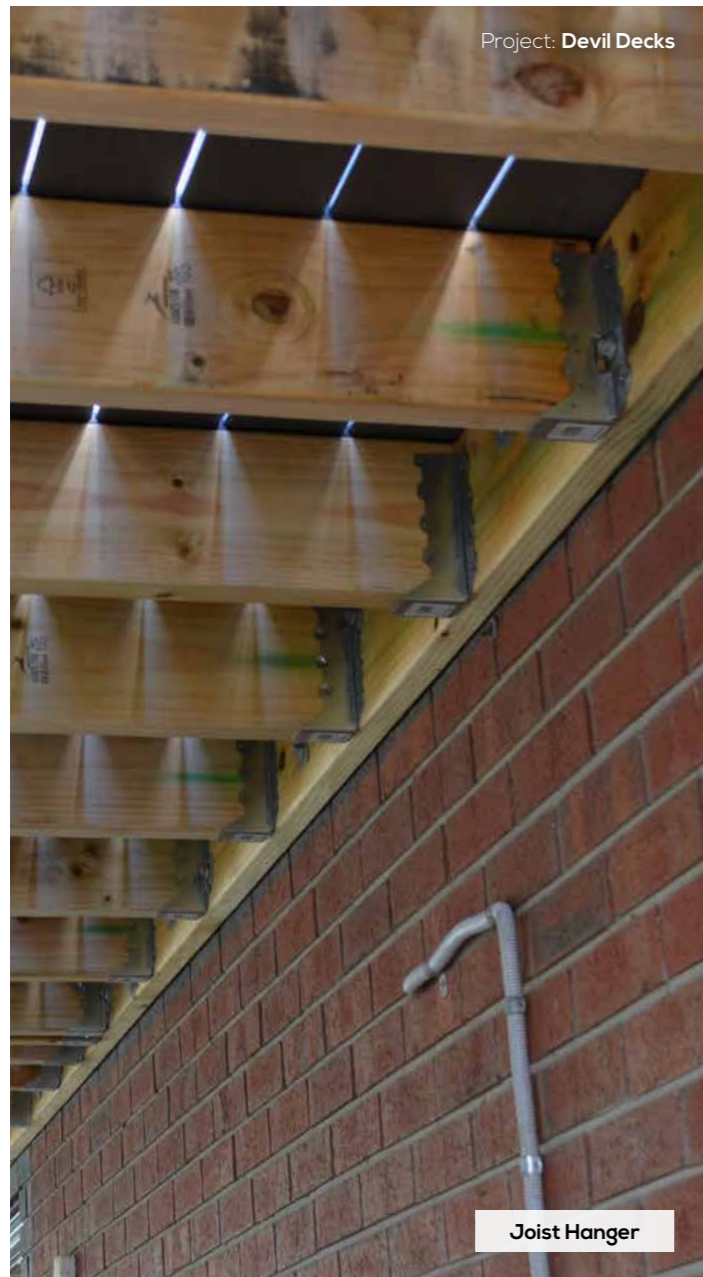

# FRAMING CONNECTORS

## Joist Hanger

Order Page: 51 / 83

### Unique VUESPIKE

- Hands free after hammered in to keep in position

### Meets and Exceeds AS1720

- The Australian Standard of Design Methods for Timber Structures

### 1.0mm thick steel

- Made out of quality G300 Z275 Pre-Galvanised or Stainless Steel 316

### Packed straight

- Consistently packed comfortably into our carton, ready to use

### Australian Made

- Locally made to high standards and allowing an easy way to support Australian jobs

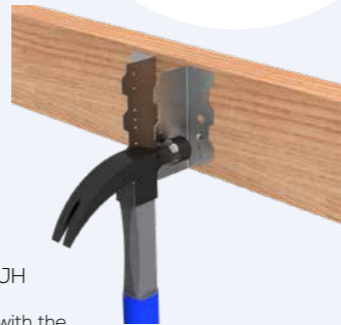
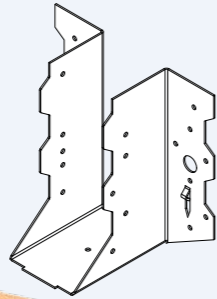

Product Code: VJH

Compliant with the requirements of AS1684 and AS1720.



Available in Galvanised, Stainless Steel & BLACKOUT



## BLACKOUT Joist Hanger

Order Page: 102

### 45 x 90mm & 45 x 140mm versions

- Covers the most common sizes for joists and beams used for Australian decks and pergolas

### Australian Made

- Locally made product that supports the manufacturing industry within Australia

### Meets and Exceeds AS1720

- The Australian Standard of Design Methods for Timber Structures

### 1.0mm thick steel

- Made out of quality G300 Z275 Pre-Galvanised and powder coated with our matte black BLACKOUT finish

### Secure with nails or screws

- VUETRADE Connector Plate nails or Screws are both suitable methods of installation, see Technical Data for more installation tips

Product Code: VJH-BK

Compliant with the requirements of AS1684 and AS1720.



Powder Coated



Also available in Galvanised and Stainless Steel.

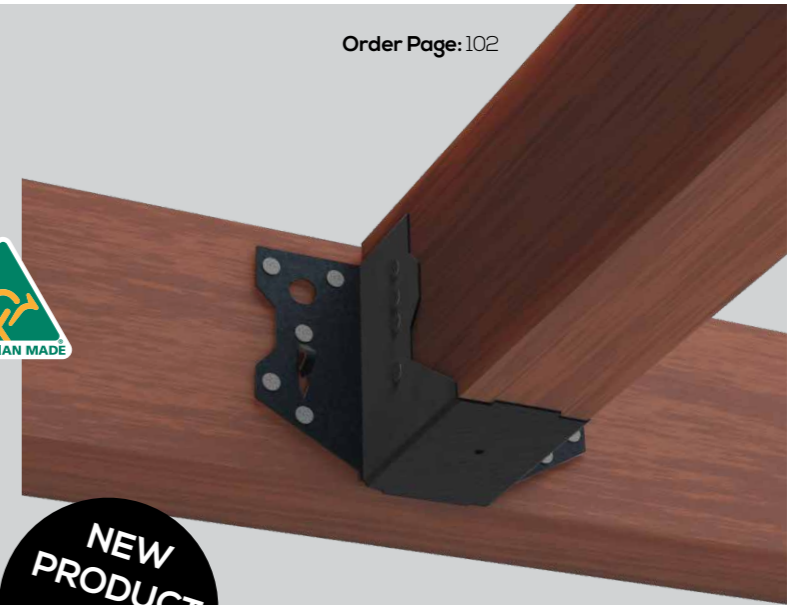

45 x 90mm



VJH4590BK

45 x 140mm



VJH45140BK

## Split Joist Hanger

Order Page: 52 / 88

### Two-piece Joist Hanger

- Use for larger timbers that a regular joist hanger can't fit, or when dealing with unknown timber widths until on-site

### 120-220 mm Hanger Depths

- To suit a variety of timber heights

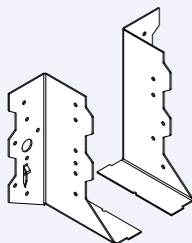

Product Code: VSJH

Compliant with the requirements of AS1684 and AS1720.



Available in Galvanised and Stainless Steel.



## I-Beam Hanger

Order Page: 53



### 17 separate sizes

- To suit the most common I-Beams of 200 to 400mm depths & 40 to 90mm widths.

### Australian Made

- Supporting local production with minimised supply chain issues

### Use with 35mm screws or 33 x 3.15mm nails

- Install using your preferred method

Product Code: VIBHF

Compliant with the requirements of AS1684 and AS1720.



Available in Galvanised.

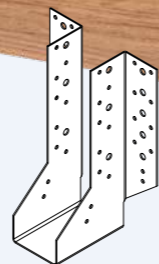

## Joist Straps

Order Pg: 55 / 85



### VUESPIKE

- Save time with connecting to timber before fixing with nails

### Ceiling Joists or Rafters to Hanging Beams

- Quick and easy

Product Code: VTJS

Compliant with the requirements of AS1684.



Available in Galvanised and Stainless Steel.



## Heavy Duty Joist Straps

Order Page: 55

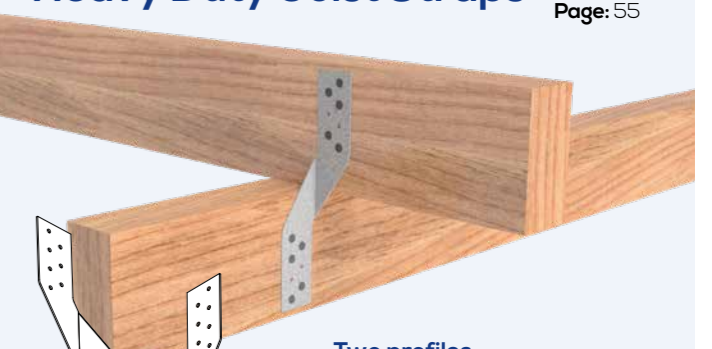

LEFT

RIGHT

### Two profiles

- Available in Left & Right profiles

### 1.0mm thick G300 Z275 steel

- Strong solution for fixing joists

### 170mm height

- Use for a variety of timber sizes

Product Code: VTHDJ

Compliant with the requirements of AS 1684. Tested in accordance to AS1649.



Available in Galvanised.



# FRAMING CONNECTORS

## Triple Grips

Order Page: 54 / 84

- Perpendicular angles**  
- Ready for use on 90-degree angle joints
- Left and Right hand profiles**  
- Perfect fit for your project
- Stainless Steel 316 or Galvanised**  
- Prepare for your environment

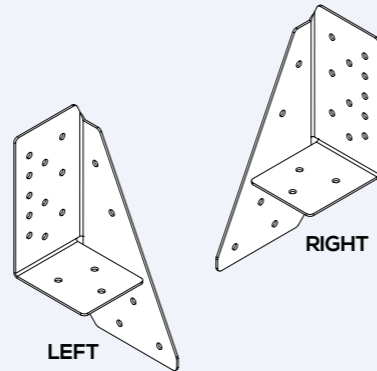

Product Code: VTTG

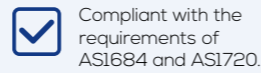

Available in Galvanised and Stainless Steel.



## Stud-Smart Screws

Order Page: 60



- Compliant to Australian Standards**  
- Suitable replacement for stud strapping.

- Two sizes**  
- Correctly pick for either single or double top plate installations.

- Wide coloured head**  
- Accurately identify and confirm correct installation for safety and compliance.

Product Code: ST140 & ST185

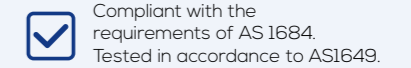

Available in Galvanised.

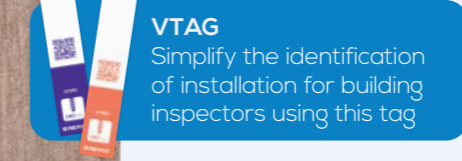

**V-TAG**  
Simplify the identification of installation for building inspectors using this tag

## Mini Grips

Order Page: 54 / 84

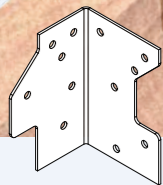
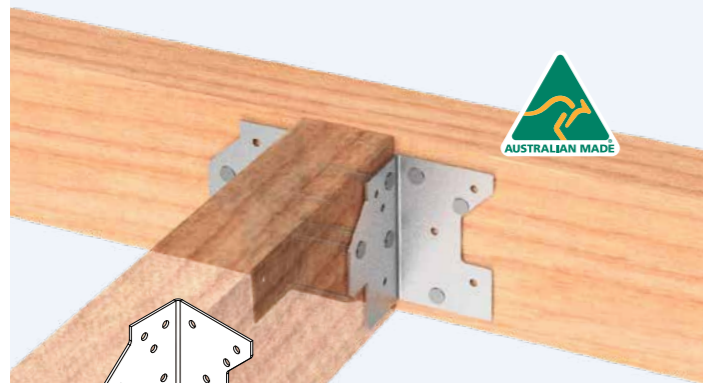

- Economical Connector**  
- For lightly loaded joints

- Australian Made**  
- High quality and supporting the Australian economy

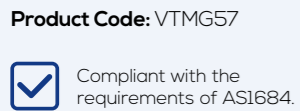

Available in Galvanised and Stainless Steel.

- Nail hole pattern**  
- Designed to avoid nails impacting from opposite end of timber

## Multi Grips

Order Page: 54 / 85

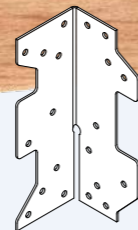

- Versatile and Cost Effective**  
- Bend to suit your installation

- Suitable for framing applications**  
- In accordance with AS1684.2 and AS1684.3

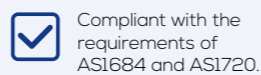

Available in Galvanised and Stainless Steel.

- Galvanised or Stainless**  
- Use the material appropriate for your environment

## Single Sided Stud Ties

Order Pg: 56



- VUESPIKES**  
- Easy installation, spike to secure, to and act as a third hand to hold into place before nailing in

- Right Angle folded**  
- Shaped ready to use, no springing back as seen in inferior pressed versions

- Galvanised finish**  
- For durability and long-life installation

Product Code: VTST

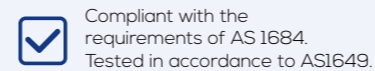

Available in Galvanised.

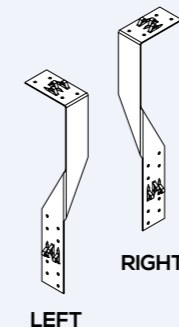

## Stud Ties

Order Page: 56

- Tap in "teeth"**  
- Easy and fast installation process for both sides of the stud

- Top or Bottom Plate**  
- Can be used to secure on either end as required

- Galvanised finish**  
- For durability and long-life installation

Product Code: VTST4U90

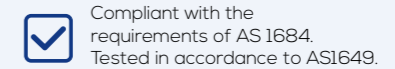

Available in Galvanised and Stainless Steel.

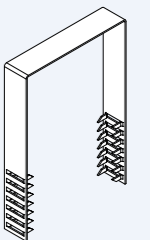

# FRAMING CONNECTORS

## Connector Plate Nails

Order Page: 59 / 86

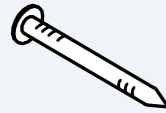

**30 x 2.8mm**  
- Used to secure VUETRADE framing connectors

Product Code: VTCPN

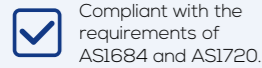

Available in Galvanised and Stainless Steel.

**645 nails p/kg**  
- Available in 500g, 2kg and 5kg

**33 x 3.15mm I-Beam nails**  
- Available to compliantly connect and secure VUETRADE I-Beam hangers

## Connector Plate Screws

Order Pg: 59 / 86

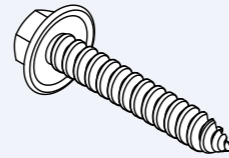

**Designed for VUETRADE products**  
- Used to fasten VUETRADE framing connectors

Product Code: VTCPS



Available in Galvanised and Stainless Steel.

**35 / 65mm lengths**  
- Connect to single or double laminate

**5/16 Hex Drive**  
- Standard driver size for convenience

## Tap in Plates

Order Page: 58 / 85

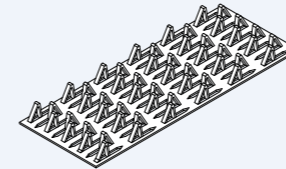

**Timesavers**  
- "Teeth" that create strong and secure connection

Product Code: VTIP

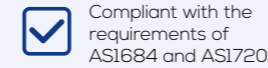

Available in Galvanised and Stainless Steel.

**Timber wall frame and top plate connection**  
- Fast and secure

**Galvanised or Stainless**  
- Use the material appropriate for your environment

## Strap Nails

Order Page: 57

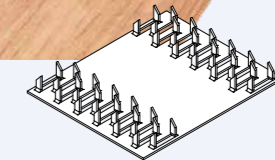
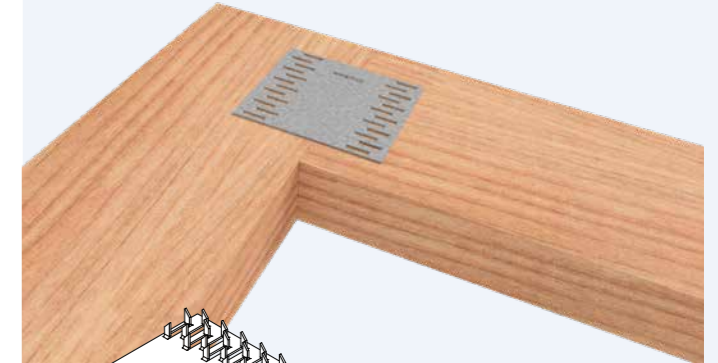

**Tap in Spikes**  
- Quick jointing method of timber frames

**Twisted Spike Design**  
- Creates solid connections once hammered in

Product Code: VTSN

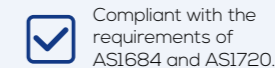

Available in Galvanised.

**Galvanised Finish**  
- Durable and long-life

## Foil Tacks

Order Page: 57

**Wide Size & Rounded Edges**  
- Tear resistant

**Twisted Spikes**  
- Excellent holding power

**Strips of 10**  
- Convenient quantities in boxes of 500 tacks



Product Code: VTFT

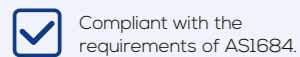

Available in Galvanised.

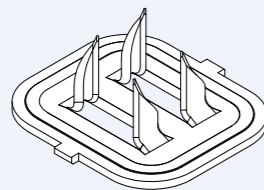

## Insul Fix Fastener

Order Page: 56



**Rounded Edges**  
- Tear Resistant

**Strips of 10**  
- Convenient quantities in boxes of 500 fasteners

**Insert nail to secure**  
- Simple installation

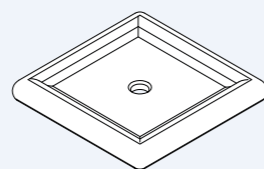

Product Code: F81006

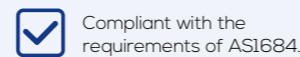

Available in Galvanised.

## VUEFIX Truss-Screws

Order Page: 60

**150mm length**  
- Comfortably secure through double top plate with sufficient embedment into truss / rafter

**Replace or complement the use of Cyclone Straps**  
- Installation from below allows for easier installation, or with use of a cyclone strap for additional tie-down capability

Product Code: TS150



Available in Galvanised.

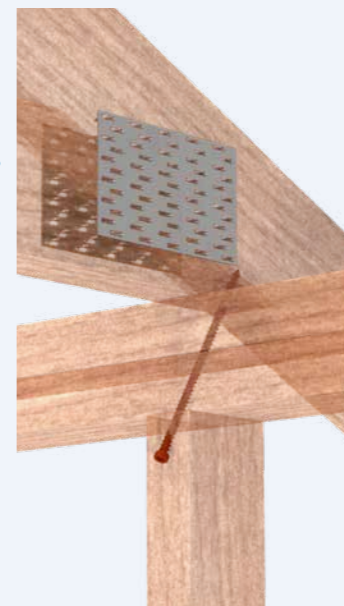
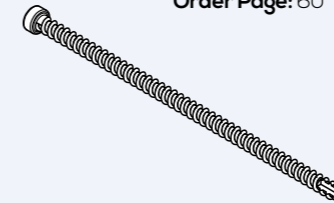

## Cyclone Strap

Order Page: 55



**400 - 900mm lengths**  
- To suit your requirements

**Economical price point**  
- Accessible upgrade to increase durability of build in the long term

Product Code: VTCS

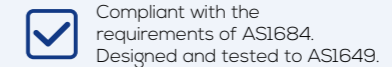

Available in Galvanised.

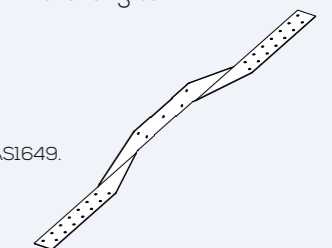

# BUILDING BRACKETS



Bearer Plate  
pg 20



Pergola Angle  
pg 20



Internal Wall Bracket  
pg 20



Hold Down Bracket  
pg 20



Ultra Heavy Duty Angle  
pg 21



Structural HDG Bracket  
pg 21



L Type HDG Bracket  
pg 21



Plates - Heavy Duty  
pg 22



Angle Bracket  
pg 22



Z Type HDG Bracket  
pg 22



Fascia Bracket  
pg 22



I-Beam Variable Skew Angle  
pg 23



L Type HDG Bracket



Internal Wall Bracket



Angle Bracket



Ultra Heavy Duty Angle

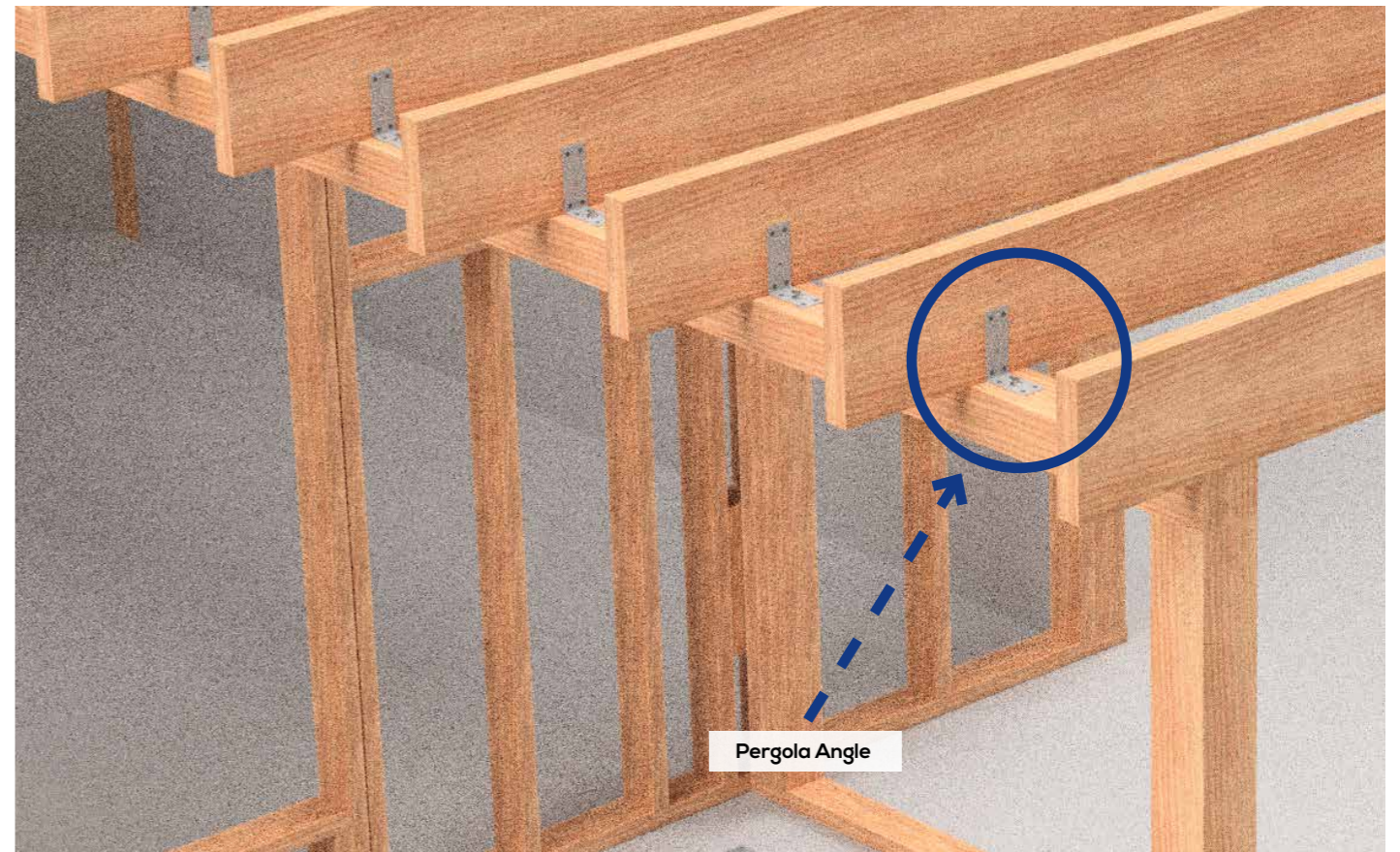

Pergola Angle



Hold Down Bracket



Fascia Bracket



# BUILDING BRACKETS

## Bearer Plate

Order Page: 61 / 87

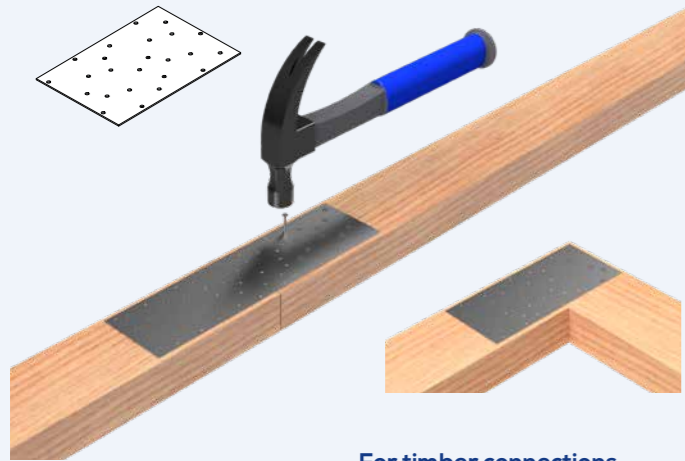

Product Code: VTBP

Compliant with the requirements of AS1684.



Available in Galvanised and Stainless Steel.

**For timber connections**  
- Repair or reinforcement of timber framing

**1mm thick stainless steel**  
- Ideal for heavy duty applications

**Available in 4 lengths**  
- 80 x 120mm  
- up to 80 x 300mm  
to suit your project

## Pergola Angle

Order Page: 61 / 87



**Pergola Rafters**  
- Are the main location these brackets are used

**1.6mm thick steel**  
- Extra Strength

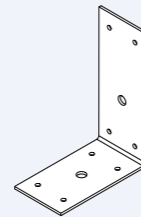

Product Code: VTPA36

Compliant with the requirements of AS1684 and AS1720.



Available in Galvanised, Stainless Steel & BLACKOUT

## BLACKOUT Pergola Angle

Order Pg: 102

**Black powder coated**  
- Same design as Galvanised Pergola Angle, but has gone through BLACKOUT powder coating procedure for refined look suiting darker or stained timbers.

Product Code: VTPA36BK



## BLACKOUT Hold Down Bracket

**The only black powder coated hold down bracket**  
- For use in high visibility locations where a black hold down bracket would visually suit.

Product Code: VTHDBBK



## Ultra Heavy Duty Angle

Order Page: 62

**Multi-purpose right angled bracket**  
- Suited for staircase amongst other applications

**2.0mm thick stainless steel**  
- Ideal for heavy duty applications

Product Code: VTUHDA4040

Compliant with the requirements of AS1684 and AS1720.



Available in 304 Stainless Steel and BLACKOUT

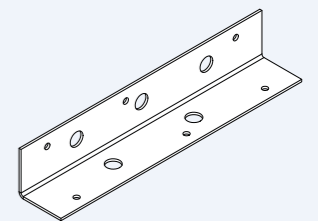

## Internal Wall Bracket

Order Page: 61

**Stabilise internal walls**  
- Allow for vertical movement of trusses, yet restrict horizontal forces.

**Australian Made**  
- Supporting local production and industries.

**1.5mm thick galvanised with middle ridge**  
- A strong bracket with ridge to show distance of nails to allow for vertical movement.

Product Code: VTPA47

Compliant with the requirements of AS1684 and AS4440.



Available in Galvanised.

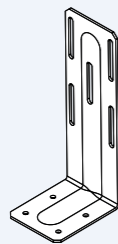

## Hold Down Bracket

Order Page: 62 / 88



**Wall Studs and Roof Truss**  
- To suit fixing with nails and bolt to meet Australian Standards

Product Code: VTHDB

Compliant with the requirements of AS1684 and AS1720.



Available in Galvanised, Stainless Steel & BLACKOUT

**2.0mm thick steel**  
- For extra strength in any chosen material

**No sharp edges**  
- Avoid injury and excessive precautions whilst installing

## Structural HDG Bracket

Order Pg: 64

**5.0 to 8.0mm thick steel**  
- Each bracket clearly marked with thickness and hot-dipped galvanised for increased resistance.

**M12 / M16 holes**  
- Industry standard bolt sizes for rectification and joining work.

Product Code: VABHS

Engineered. Tested. Industry proven.

Available in Galvanised.

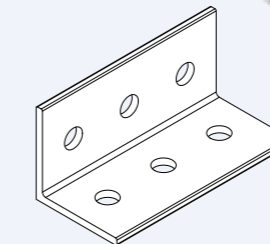
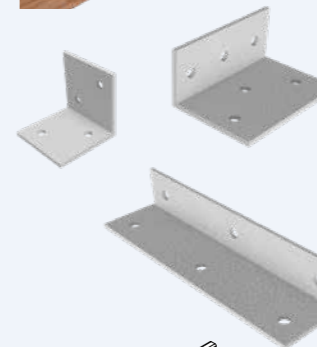

## L Type HDG Bracket

Order Page: 65

**5.0 / 6.5mm thick steel**  
- Designed for applications to be fixed by bolts.

**Versatile Use**  
- Right angle bracket that can be used for a variety of purposes.

Product Code: VABL

Engineered. Tested. Industry proven.

Available in Galvanised.

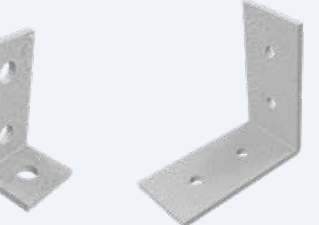
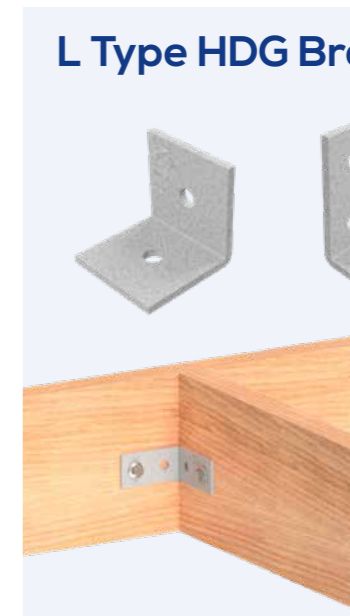

# BUILDING BRACKETS

## Plates - Heavy Duty

Order Page: 66 / 89

### 3.0mm thick pre-galv or stainless steel

- For extra strength with M10 connection bolt holes

### Flat timber connections

- Minimise additional timber and strengthen splices

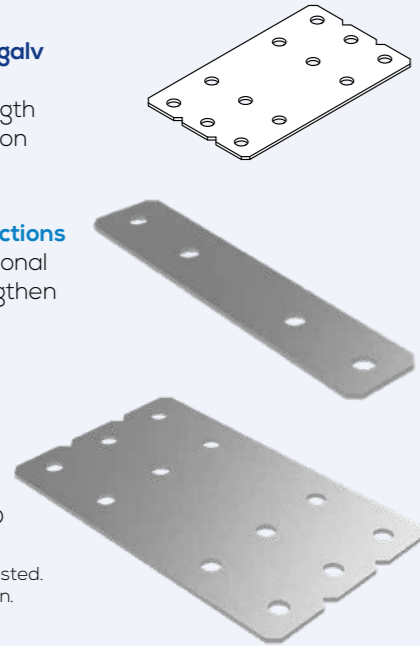

Product Code: VPHD



Available in Galvanised and Stainless Steel.

## Angle Bracket

Order Page: 63 / 88

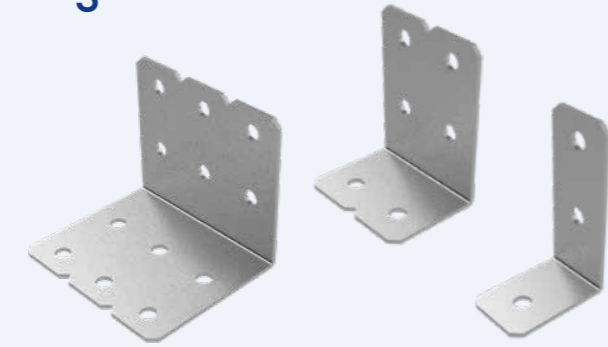

### 3.0mm thick pre-galv or 316 Stainless Steel

- For extra strength with M10 connection bolt holes

### Stair and shelf bracket

- As well as other locations where right angle timber connections are required

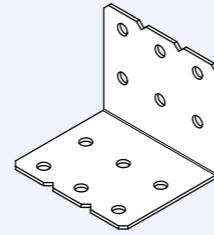

Product Code: VABHD



Available in Galvanised and Stainless Steel.

## I-Beam Variable Skew Angle

Order Page: 67

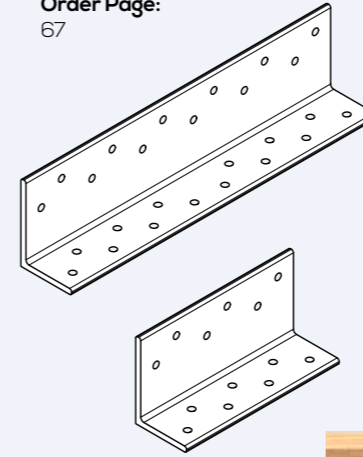

### 5.0mm thick hot-dipped galvanised

- Strong right angle bracket for I-Beam or timber use.

### Install with 35mm screws

- Simple installation process, quick and easy.

### Two lengths

- 150 and 300mm



Product Code: VIBVSA

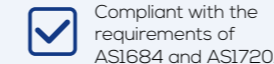

Available in Galvanised.

## Z Type HDG Bracket

Order Page: 65

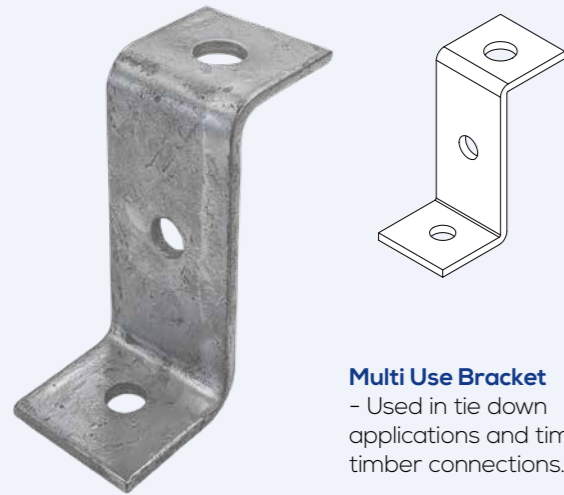

### Multi Use Bracket

- Used in tie down applications and timber connections.

### 5.0mm thick steel

- Heavy Duty bracket.

### Hot-Dipped Galvanised

- Resistant against corrosion.

Product Code: VBZG

Available in Galvanised.

## Fascia Bracket

Order Page: 67



### 6.0mm thick bracket

- A strong connection between fascia and existing rafters.

### Hot-Dipped Galvanised

- Corrosion resistant in regular non-coastal environments.

### M10 Bolt Holes

- Standard size bolts for this application.

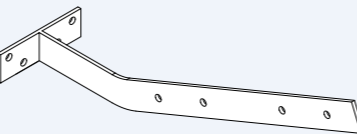

Product Code: VTHDFB

Compliant with the requirements of AS1684 and AS1720. Designed and tested to AS1649.

Available in Galvanised.



FIND US ON SOCIAL MEDIA

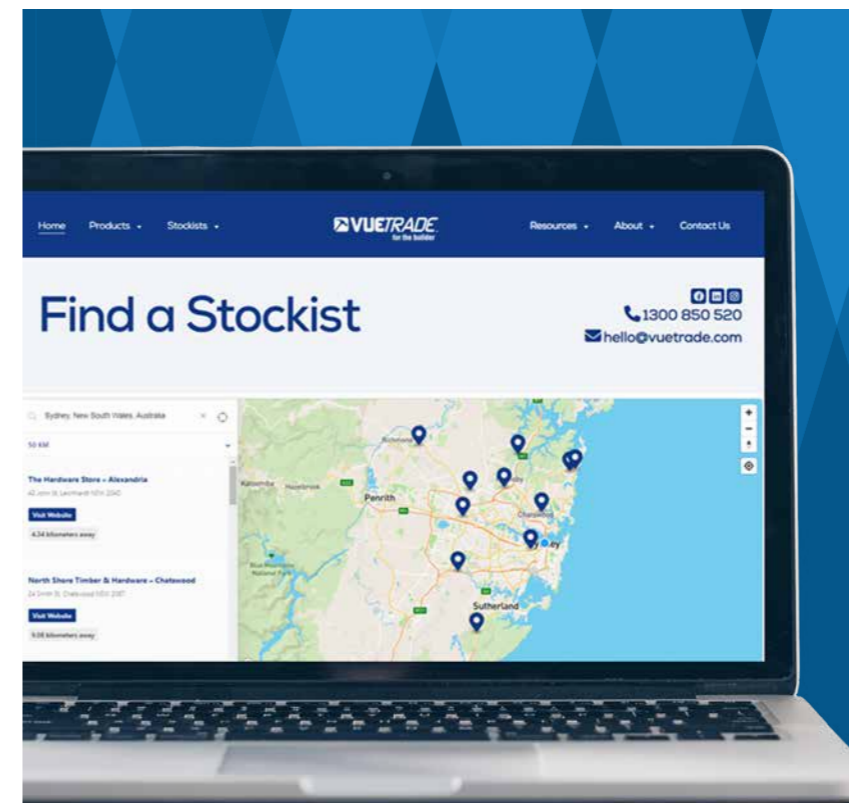

SEE INSTALLATION VIDEOS, TECHNICAL DATA & STOCKIST LOCATIONS ON OUR WEBSITE

**vuetrade.com**



# MASONRY TIES & VENTS

-   
Brick Veneer Ties  
pg 26
-   
Expansion Ties  
pg 27
-   
Double Sleeve Expansion Ties  
pg 27
-   
Frame Ties  
pg 27
-   
Twisted Brick Veneer Ties  
pg 27
-   
Sub Floor Vents  
pg 28
-   
Flat Faced Vents  
pg 29
-   
Ant Cap  
pg 29

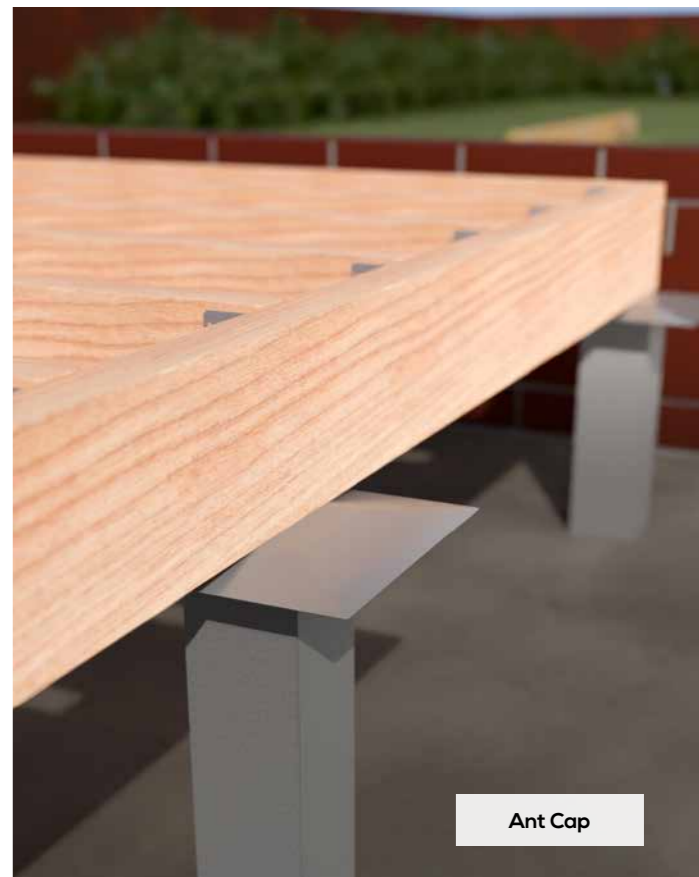
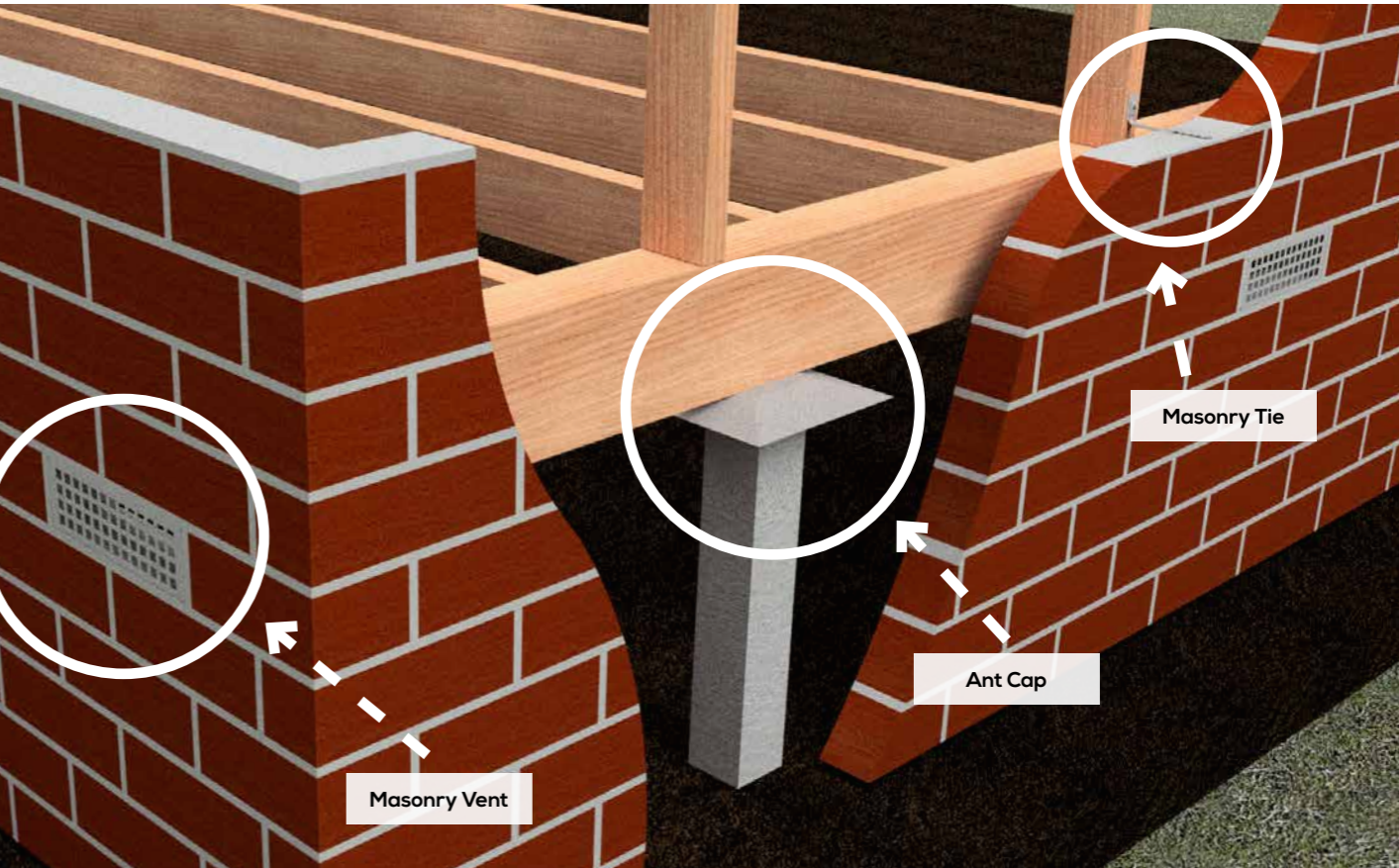
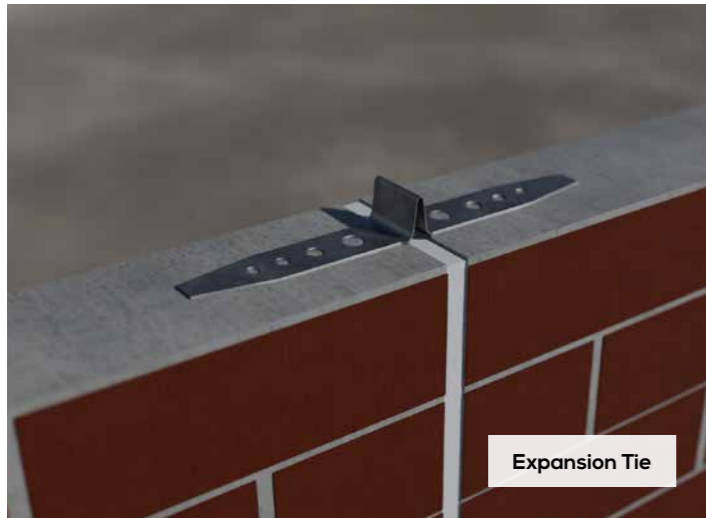

# MASONRY TIES

## Brick Veneer Ties

### Secure to timber

- Allows masonry structures to be attached to the timber frame. The fixings are supplied with the ties and are clearly marked for both durability and duty classifications.

### AS2699.1 Compliant

- To be compliant with the Australian Standard, the tie must adhere to strict manufacturing requirements along with testing to confirm its strength meets the required classification class.

Order Page: 75

R2

R3

R4

Product Code: VBT

Compliant with the requirements of AS2699 and AS3700.



Available in Galvanised and Stainless Steel.

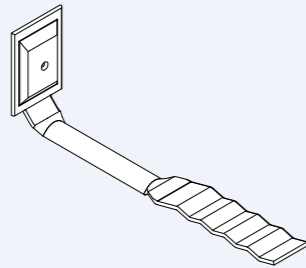

## Light Duty



### Nail Fixing Supplied

- Provides resistance against pull-out forces.

### Three Durability Classes

- R2, R3 and R4 rated to suit your environment.

### Light Duty Rated

- Mean strength rated to perform to the requirements of a Light Duty wall tie as stated in Table 2.1 of AS 2699.1:2020.

## Medium Duty



### Screw Fixing Supplied

- Provides excellent resistance against pull-out forces.

### Three Durability Classes

- R2, R3 and R4 rated to suit your environment.

### Medium Duty Rated

- Mean strength rated to perform to the requirements of a Medium Duty wall tie as stated in Table 2.1 of AS 2699.1:2020.

## Expansion Ties

Order Page: 76 / 97



### One part install

- Easy installation and allows for a maximum control gap of 20mm

### R2 & R4 Ratings Available

- Pick the option that is suited for your site, whether it is a low or high corrosion area, as required for compliance with AS 2699

Product Code: VTEXT

Compliant with the requirements of AS2699 and AS3700.



Available in Galvanised and Stainless Steel.

R2

R4



## Double Sleeve Expansion Ties

Order Page: 76 / 97



### Two-part system

- Rods are located within the sleeve, which allow them to move freely within a maximum control gap of 50mm

### Galvanised & Stainless

- Metal material to suit the environment in which your project is located

Product Code: VTDS

Compliant with the requirements of AS2699 and AS3700.



Available in Galvanised and Stainless Steel.

R2

R4

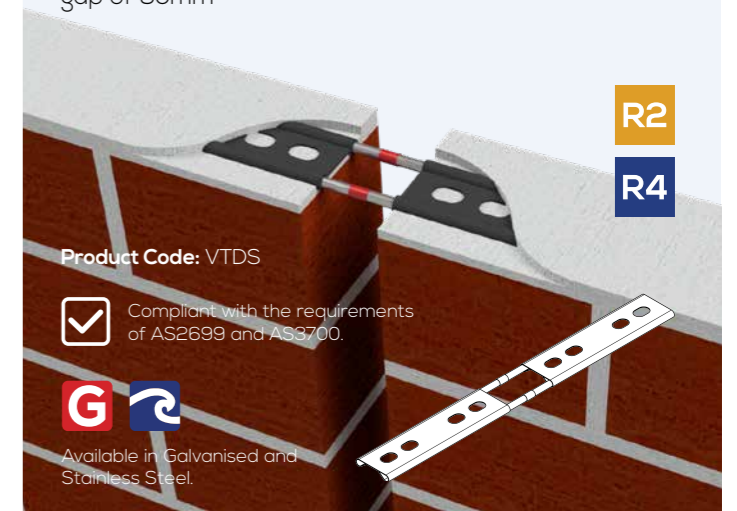

## Frame Ties

Order Page: 76

R2

### 230mm Length

- A long crimped section means increased grip area, ideal to tie off frame to brick work, as well as to assist in renovations of sandstone block walls.

### Z600 Galvanised

- R2 Rated, meaning it can be installed in masonry walls in most inland environments which are not within a close proximity to the coast.

Product Code: VTBTFT

Available in Galvanised.

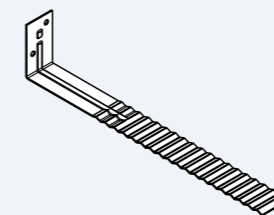

## Twisted Brick Veneer Ties

Order Page: 75

R2

### Side-fixing wall tie

- For brick tie installation where it is more suited to fix into the timber frame from the side rather than the front.

### Nails supplied with ties

- To ensure compliant and secure installation, nails are supplied in the same box as the masonry ties.

### Z600 Galvanised

- Durability Classification of R2.

Product Code: VTTWBV

Available in Galvanised.

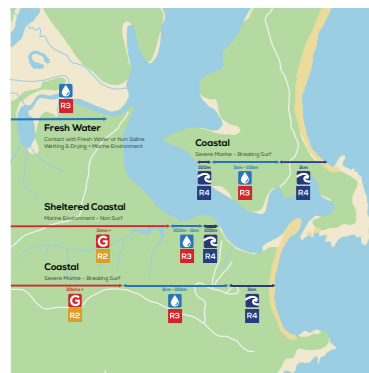
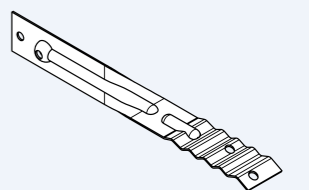

## Further Information

### Specification Area Chart

- Chart to assist with where different material grades are required to suit the environment in accordance with Australian standards.

### Brick Tie Specification Guide

- For a detailed explanation of the brick tie ratings in regards to loads and corrosion resistance.

### Technical Data Sheets

### Standards and Codes:

- National Construction Code 2022 - ABCB Housing Provisions, AS2699.1:2020 *Built-in components for masonry construction Part 1: Wall ties.*

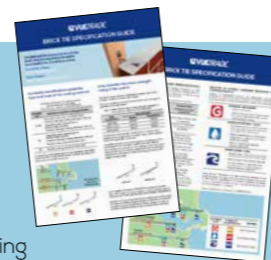

# MASONRY VENTS

## Sub Floor Vents

Order Page: 77 / 98

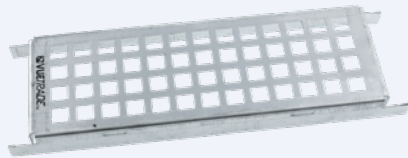

Punched Grid

### Ventilation

- Installing this during the build of your masonry sub-floor wall will increase the opportunity for air to flow to areas where otherwise moisture could build up.

Prolonged sub floor area moisture can cause structural problems.

### Various Sizes

- Range to suit most common brick and block sizes. Each size has a calculated air flow value which is available in its Technical Data Sheet.

### Louvred Alternative

- Suited for a discreet look or where a wall is exposed to the weather, the louvred sub floor vent limits visibility and rain fall whilst retaining air movement to and from the sub floor area.



Louvred

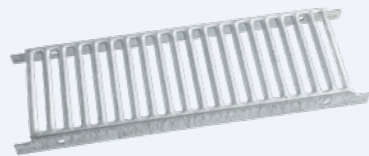

Slim Version

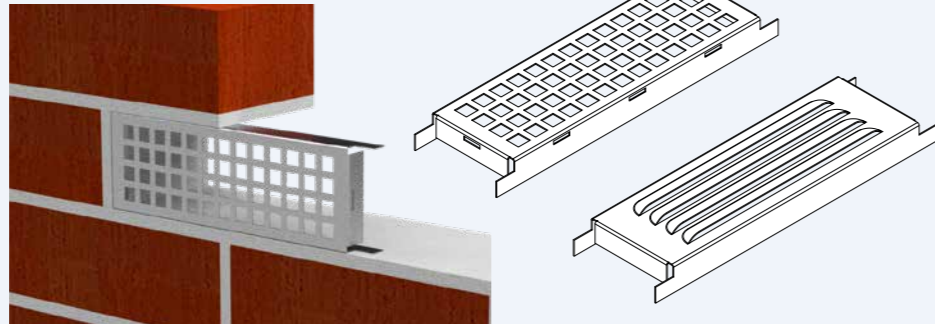

Product Code: VTSFV

Compliant with the requirements of NCC2022.



Available in Galvanised, Stainless Steel & BLACKOUT

## Anti-Spark Mesh BAL-40 Rated

Order Page: 79

### AS 3959:2018 BAL-40

- Be bushfire prepared and compliant with your vents with the inclusion of this anti-spark mesh to your vents.

### Stainless Steel 316

- In line with the requirements in the Standard, the mesh is made from stainless steel wires of 0.9mm in diameter and has an aperture of 1.64mm.

Compliant with the requirements of AS3959.

Stainless Steel 316

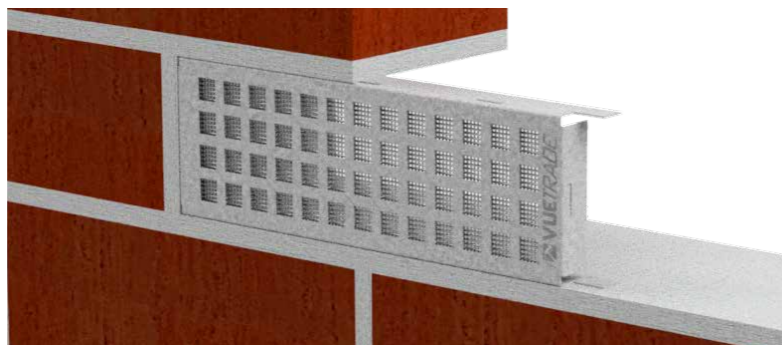
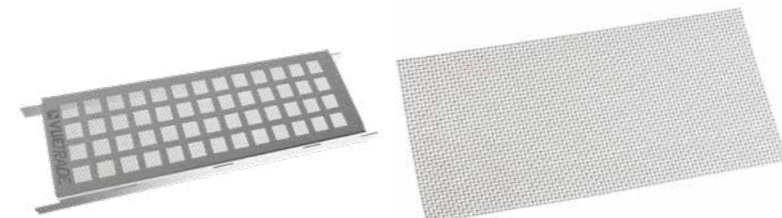

## Flat Faced Vents

Order Page: 78

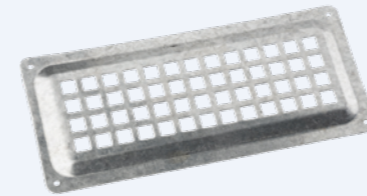

Punched Grid

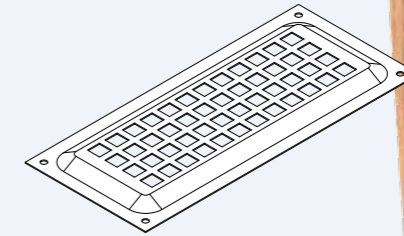

### Flat Connection

- Simply nail or screw in on the edges to create a flush connection to sheeting or wall.

### Two Sizes

- 250 x 110mm and 260 x 200mm to match your site or required air flow.

### Create air flow in an existing wall

- Renovation or retrospective installation suited, and creates air flow without allowing larger debris to enter or exit.

Each vent size has a calculated air flow value available in the Technical Data Sheet.

Product Code: VTFF

Compliant with the requirements of NCC2022.

Available in Galvanised.



Order Pg: 74

## Ant Cap

### Show termite activity

- Ideal to cover timber base to force termites to traverse externally and make visual inspections simpler

### 100 x 100 mm with 25mm flange

- Able to use within coastal and termite-prone environments

Product Code: VAC / ANTCAPSS

Compliant with the requirements of AS36601.



Available in Galvanised and Stainless Steel.

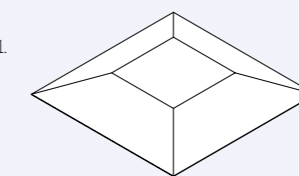

## BLACKOUT Punched Grid Sub Floor Vent

Order Page: 102

### 230 x 76mm in matte black

- Stand out without being visible! The BLACKOUT timber connector range provides the same quality and capacities as their galvanised counterparts - but with a discreet twist.

Compliant with the requirements of NCC2022.

Also available in Galvanised and Stainless Steel.

230 x 76mm



VTSFV230X76BK



Powder Coated

Product Code: VTSFV230X76BK



# POST SUPPORTS

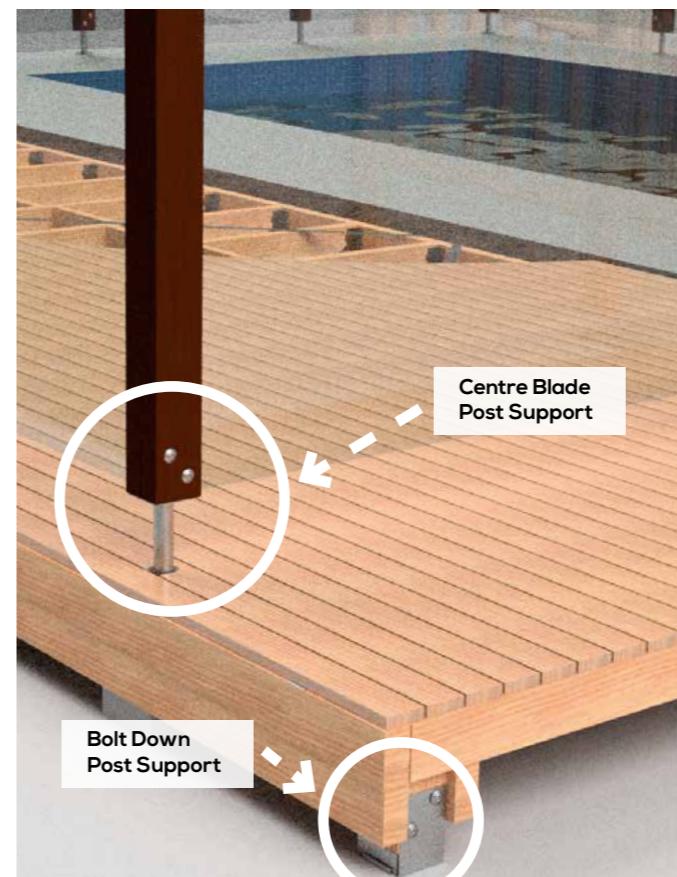
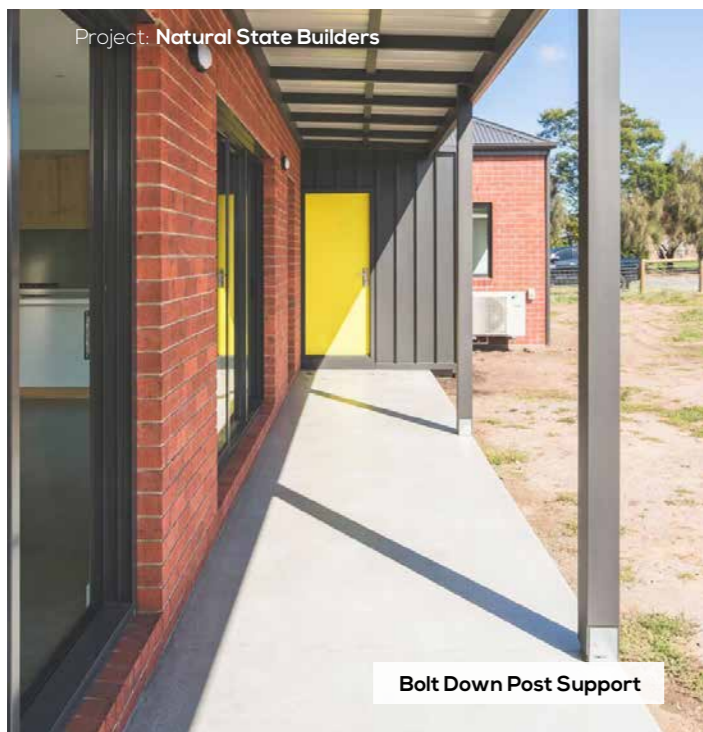
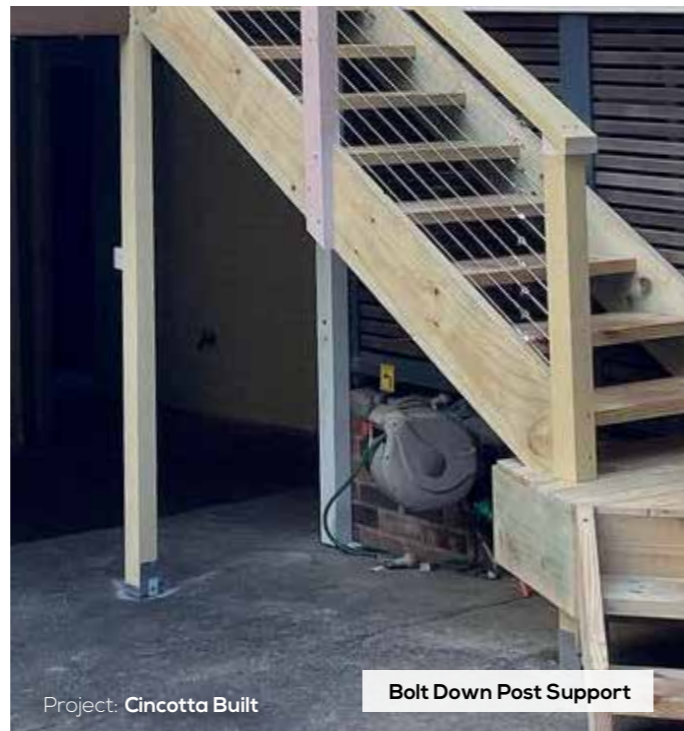

# POST SUPPORTS



## T-Blade

**Neat finish**  
- Showing more timber and less metal

**Online Timber Cutting Resources**  
- Making installation even easier

**10.0 or 12.0mm Thick Blade and Base**  
- For a strong, reliable ground connection

**Concealed Welds**  
- Creates a reinforced connection stronger than similar products featuring a top weld

**Order Page:** 73 / 94  
**Product Code:** VBPTB



Compliant with the requirements of AS1720.

**Available in Galvanised, Stainless Steel & BLACKOUT**

**Concealing Caps**  
- Give a tidy and better protected finish, hiding the installation anchoring bolts and the bottom end of the post

**90 - 350 mm**  
To Suit Timber Post Size (square)

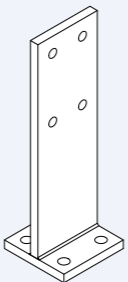
T-BLADE POST SUPPORT  
CONCEALING CAP

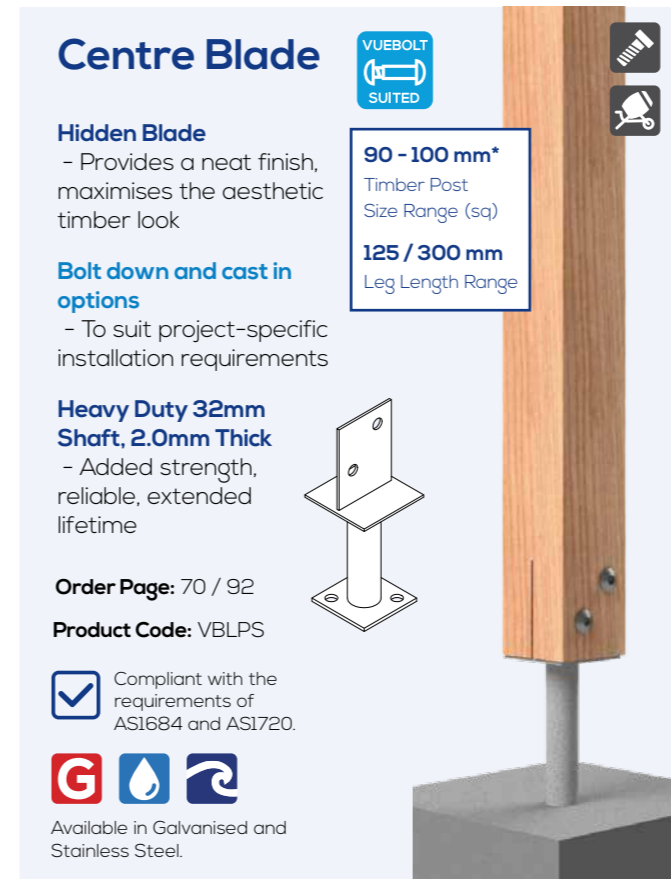
## Centre Blade

**Hidden Blade**  
- Provides a neat finish, maximises the aesthetic timber look

**Bolt down and cast in options**  
- To suit project-specific installation requirements

**Heavy Duty 32mm Shaft, 2.0mm Thick**  
- Added strength, reliable, extended lifetime

**Order Page:** 70 / 92  
**Product Code:** VBLPS

Compliant with the requirements of AS1684 and AS1720.

**Available in Galvanised and Stainless Steel**

**90 - 100 mm\***  
Timber Post Size Range (sq)

**125 / 300 mm**  
Leg Length Range

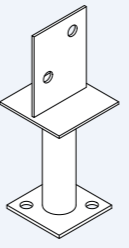

## Concealed Bolt Down

**Simple Post Preparation**  
- Reduce installation time on site.

**Architectural Finish**  
- Concealed Blade and 304 Grade Stainless Steel Cap, suited for high-profile timber posts.

**3mm thick steel blade**  
- Added strength, long life and durability.

**Order Page:** 70  
**Product Code:** VCBPS

Compliant with the requirements of AS1720.

**Available in Galvanised.**

**90 - 100 mm\***  
Timber Post Size (square)

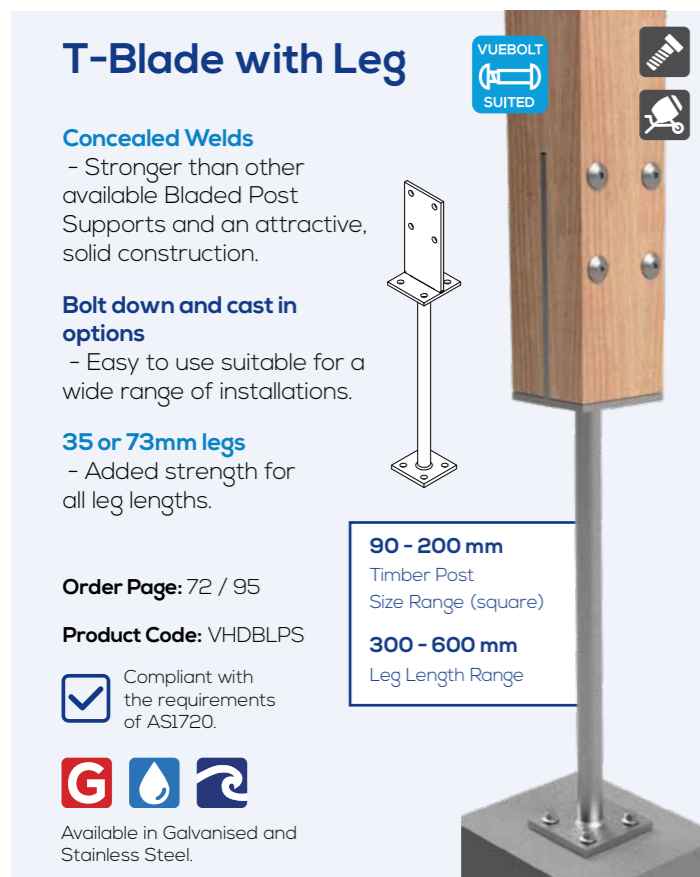
## T-Blade with Leg

**Concealed Welds**  
- Stronger than other available Bladed Post Supports and an attractive, solid construction.

**Bolt down and cast in options**  
- Easy to use suitable for a wide range of installations.

**35 or 73mm legs**  
- Added strength for all leg lengths.

**Order Page:** 72 / 95  
**Product Code:** VHDBLPS

Compliant with the requirements of AS1720.

**Available in Galvanised and Stainless Steel**

**90 - 200 mm**  
Timber Post Size Range (square)

**300 - 600 mm**  
Leg Length Range

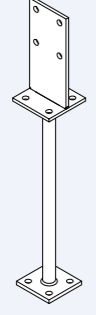

## T-Blade with Adjustable Leg

**10.0mm thick T-Blade**  
- Classic T-Blade design, but with a leg which is adjustable to suit varying ground height.

**Large leg length range**  
- Adjust as necessary.

**Order Page:** 100  
**Product Code:** VHDTRTB

Compliant with the requirements of AS1720.

**Available in Galvanised.**

**90 - 200 mm**  
Timber Post Size Range (square)

**220 - 575 mm**  
Leg Length Range



## Double T-Blade

**10.0mm thick blade**  
- For large working loads in high wind conditions.

**100 and 140mm leg lengths**  
- Height adaptability to suit your project.

**Order Page:** 101  
**Product Code:** VDTB

Compliant with the requirements of AS1720.

**Available in Galvanised.**

**140 - 230 mm**  
Timber Post Size Range (square)

**100 / 140 mm**  
Leg Length Range

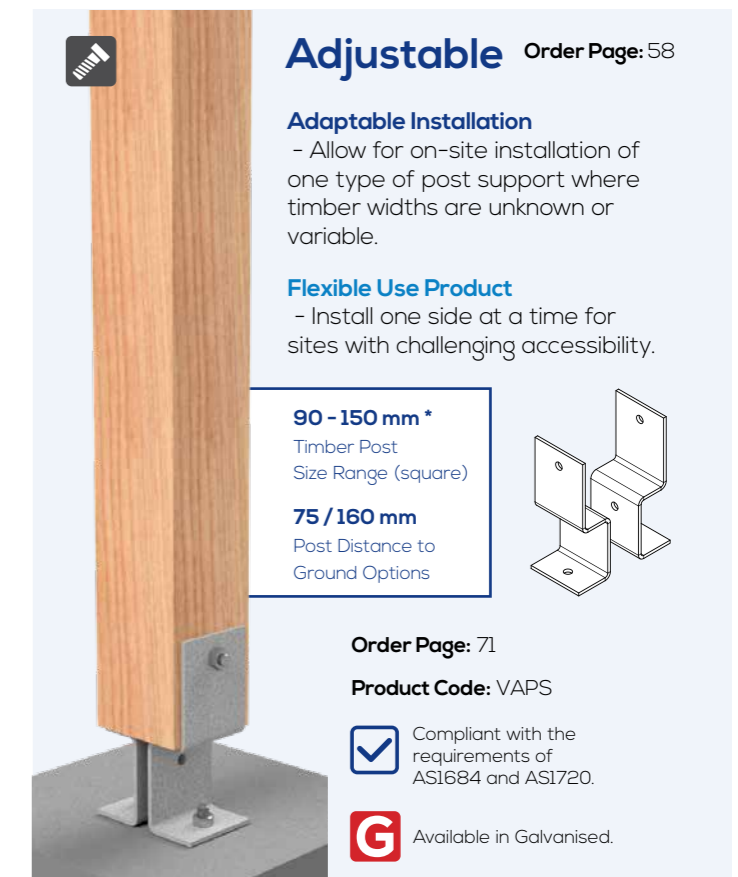
## Adjustable

**Adaptable Installation**  
- Allow for on-site installation of one type of post support where timber widths are unknown or variable.

**Flexible Use Product**  
- Install one side at a time for sites with challenging accessibility.

**Order Page:** 71  
**Product Code:** VAPS

Compliant with the requirements of AS1684 and AS1720.

**Available in Galvanised.**

**90 - 150 mm\***  
Timber Post Size Range (square)

**75 / 160 mm**  
Post Distance to Ground Options

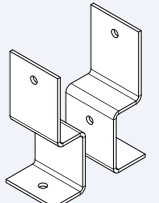

# POST SUPPORTS

## Tradies Bolt Down

**Unique open or closed finish**  
- Choose either open option for fine adjustment and adaptability, or the closed option for a clean finish.

**Australian Made**  
- High quality, peace of mind whilst supporting Aussie jobs

**Economical Price Point**  
- Suited for temporary and short-life projects.

**CHOICE OF FINISH**

90 mm  
Timber Post Size (square)

Open Finish      Closed Finish

BLACKOUT Powder Coated

Order Page: 71  
Product Code: VTBPS

Compliant with the requirements of AS1720.

Available in Galvanised and BLACKOUT

## Full Stirrup

**Wide range of leg lengths**  
- Same installation process for all leg lengths from 75 to 600mm to suit a variety of installation scenarios

**Bolt down and cast in installation options**  
- To allow for a ground anchoring solution for most applications

**Heavy Duty 2.0mm thick, 32mm Diameter Shaft**  
- Added strength for durability and long life

90 - 150 mm  
Timber Post Size Range (square)

75 - 600 mm  
Leg Length Range

Order Page: 68 / 90  
Product Code: VPS

Compliant with the requirements of AS1684 and AS1720.

Available in Galvanised, Stainless Steel & BLACKOUT

## Cyclonic

**Saddle designed for casting in to concrete**  
- Perfect for high-wind environments in cyclonic and coastal areas

**Designed to provide a gap between post and ground**  
- Prevents decay and rotting of timber posts

**6.0mm thick steel**  
- Strong, solid base design

75 - 200 mm  
Timber Post Size Range (square)

300 - 600 mm  
Bottom Half Range

Order Page: 96 / 99  
Product Code: VCYP5

Compliant with the requirements of AS1684 and AS1720.

Available in Galvanised, Stainless Steel & BLACKOUT

## Bolt Down

**Concealed Anchoring of Timber Post**  
- The cap conceals anchoring bolts whilst saddle allows for easy installation of timber post.

**Available in Galvanised and Stainless Steel**  
- Suitable for Australian conditions and locations.

**3.0 - 4.0mm thick steel**  
- Larger post sizes benefit from thicker steel for increased working loads.

90 - 200 mm  
Timber Post Size Range (square)

Order Page: 72 / 93  
Product Code: VBPS

Compliant with the requirements of AS1720.

Available in Galvanised, Stainless Steel & BLACKOUT

## Heavy Duty U-Cup

**Cyclonic Rated**  
- Specially suited for high wind areas.

**Wide Size Range**  
- Timber sizes from 75 to 150 mm.

**4.0mm thick steel**  
- The additional strength allows for this post supports use in cyclonic regions of Australia.

75 - 150 mm  
Timber Post Size Range (square)

Order Page: 100  
Product Code: VHDBPS

Compliant with the requirements of AS1720.

Available in Galvanised.

## Half Stirrup

**One sided stirrup**  
- No metal on three sides of timber for a clean finish.

**Heavy Duty 2.0mm thick, 32mm Diameter Shaft**  
- Added strength and durability for long life.

up to 150 mm\*  
Timber Post Size Range (square)

75 - 300 mm  
Leg Length Range

Order Page: 70 / 92  
Product Code: VHSP5

Compliant with the requirements of AS1684 and AS1720.

Available in Galvanised and Stainless Steel.

## Pin Shaft

**Connectors completely concealed**  
- All four timber sides retain a bolt-free finish due to the screw connection into the post base.

**Bolt down and cast in options**  
- Easy to use and suited for lower load ratings.

**Heavy Duty 32mm Shaft, 2.0mm Thick**  
- Added strength and durability for longevity.

90 - 100 mm\*  
Timber Post Size Range (square)

125 - 300 mm  
Leg Length Range

Order Page: 71  
Product Code: VPP5

Compliant with the requirements of AS1684 and AS1720.

Available in Galvanised.



# POST SUPPORTS

## Finned Blade

**6.0, 8.0 or 10.0mm thickness**

- Extra strength and rigidity for single blade design

**Galvanised finish**

- Suitable for Australian conditions and locations

**M12 Bolt Size**

- Standard bolt size

**90 - 110 mm**  
Timber Post  
Size Range (square)

**Order Page:** 101

**Product Code:** VFTB

Compliant with the requirements of ASI720.

 Available in Galvanised.



## L Stirrup

**Leg lengths from 75 to 450mm**

- Easy install onto or into concrete at required distance from ground

**Horizontal beam support**

- Unique solution for decks and raised timber decks

**85 or 140mm Blade Heights**

- Suit your timber size with ease with our two options for blade heights

**Order Page:** 101

**Product Code:** VLSPS

Compliant with the requirements of ASI720.

 Available in Galvanised.



# VUEBOLT



VUEBOLT  
Zinc-Nickel Coated  
pg 39



VUEBOLT  
316 Stainless Steel  
pg 39



BLACKOUT  
VUEBOLT  
pg 39



T50 Star Drive  
Wrench  
pg 38



Project: Crocodile Carpentry

Project: SaltBox Construction



Find your Post Support Online:



Timber Post width (square):

- 90mm
- 75mm
- 90mm
- 100mm
- 115mm
- 120mm
- 125mm
- 135mm
- 140mm
- 150mm
- 180mm

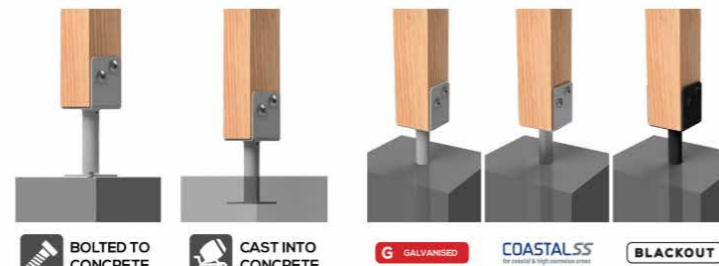

BOLTED TO CONCRETE

CAST INTO CONCRETE

GALVANISED

COASTALSS

BLACKOUT

Ground Connection:

Cast into Concrete

Support Material:

Galvanised

Scan here to head to  
[vuetrade.com/ps](https://www.vuetrade.com/ps)



ZINC-NICKEL COATED 

BLACKOUT POWDER COATED 

STAND OUT AT A GLANCE

 STAINLESS STEEL 316

Project: SaltBox Construction



# VUEBOLT

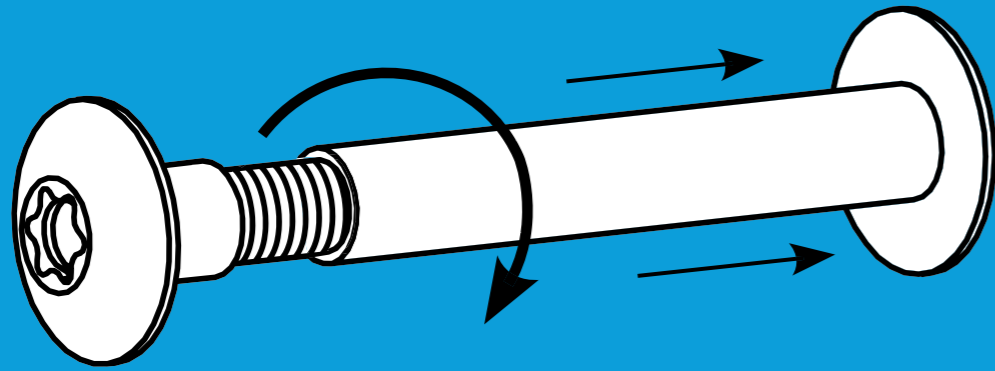

## Concealed Thread Bolt for Post Supports & Timber Connections

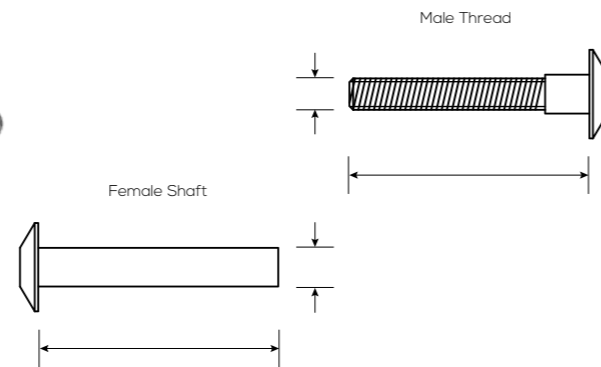

**Clean finish on both sides of the timber**  
 - Unique connecting bolt that will connect within the timber, leaving only a dome head visible on either side of the timber.

**Connect using two T50 wrenches**  
 - Available through all suppliers who stock the VUEBOLT.

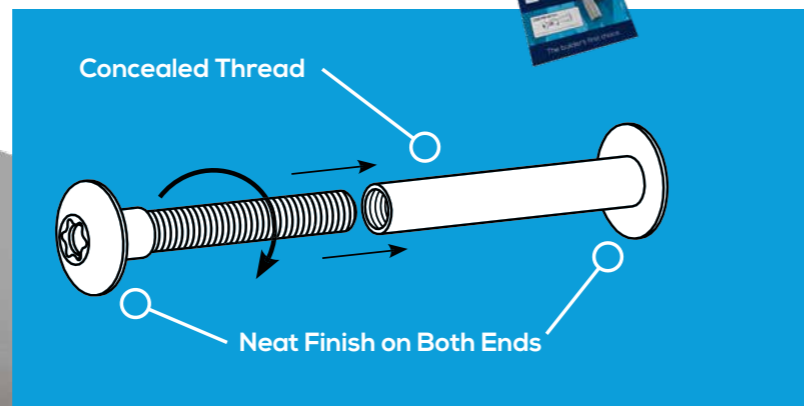

**Sizes to suit 90 to 360mm timber**  
 - Suits your timber, not matter the minor variation on timber size.

**Zinc-Nickel Coated or 316 Grade Stainless Steel**  
 - All sizes of this bolt are available in both materials to suit the environment where they will be installed.

**BLACKOUT Coated Heads**  
 - Available for a black dome head finish, suiting stained or darker timber hues.

Product Name	Diameter	Fits Post Size	Card Qty
M10 x 90 - 110mm	M10	90 - 110mm	2
M12 x 90 - 110mm	M12	90 - 110mm	2
M12 x 110 - 150mm	M12	110 - 150mm	2
M16 x 110 - 150mm	M16	110 - 150mm	2
M16 x 150 - 230mm	M16	150 - 230mm	2
M20 x 230 - 360mm	M20	230 - 360mm	1

**Product Code:** VUEBOLT

Engineered, Tested, AS Compliant.



Available in Zinc-Nickel Coated, Stainless Steel & BLACKOUT

Scan here to see the video on how the VUEBOLT works



# CYCLONIC

for high wind areas



## L Stirrup

**Designed for horizontal timber use**  
- Saddle assists in aligning timber to place

**75mm - 450mm Leg Lengths**  
- Allowing to have sufficient termite clearance to visibly see trails as well as safely secure to ground

**Order Page:** 101  
**Product Code:** VLSPS

Compliant with the requirements of AS1720.

Available in Galvanised.

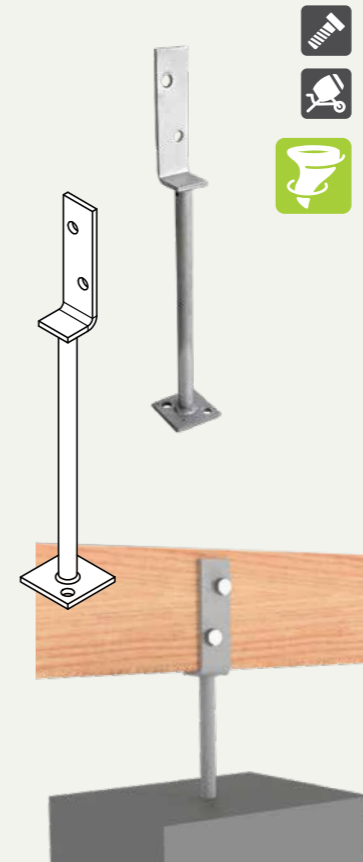

## Finned Blade

**Made for casting into concrete**  
- The fish tail design assists in restricting movement once cast

**Designed to provide a gap between post and ground**  
- Prevents decay and rotting of a timber post over its lifetime

**6.0mm and higher steel thickness**  
- 6.0mm, 8.0mm and 10.0mm thick increasing with size of the blade

**Order Page:** 101  
**Product Code:** VFTB

Available in Galvanised.

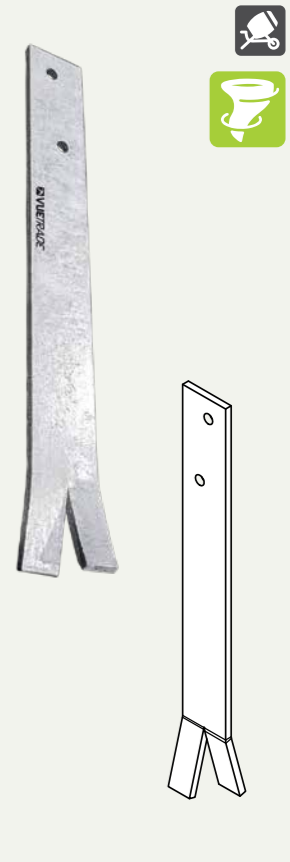

## Cyclonic Post Support

**Saddle designed for casting in to concrete**  
- Perfect for high-wind environments in cyclonic and coastal areas.

**Designed to provide a gap between post and ground**  
- Prevents decay and rotting of a timber post over its lifetime.

**Order Page:** 96 / 99  
**Product Code:** VCYPS

Compliant with the requirements of AS1684 and AS1720.

Available in Galvanised, Stainless Steel & BLACKOUT



The full range of high wind resistant connectors are in the Cyclonic Guide



Further information on [vuetrade.com/cyclonic](http://vuetrade.com/cyclonic)



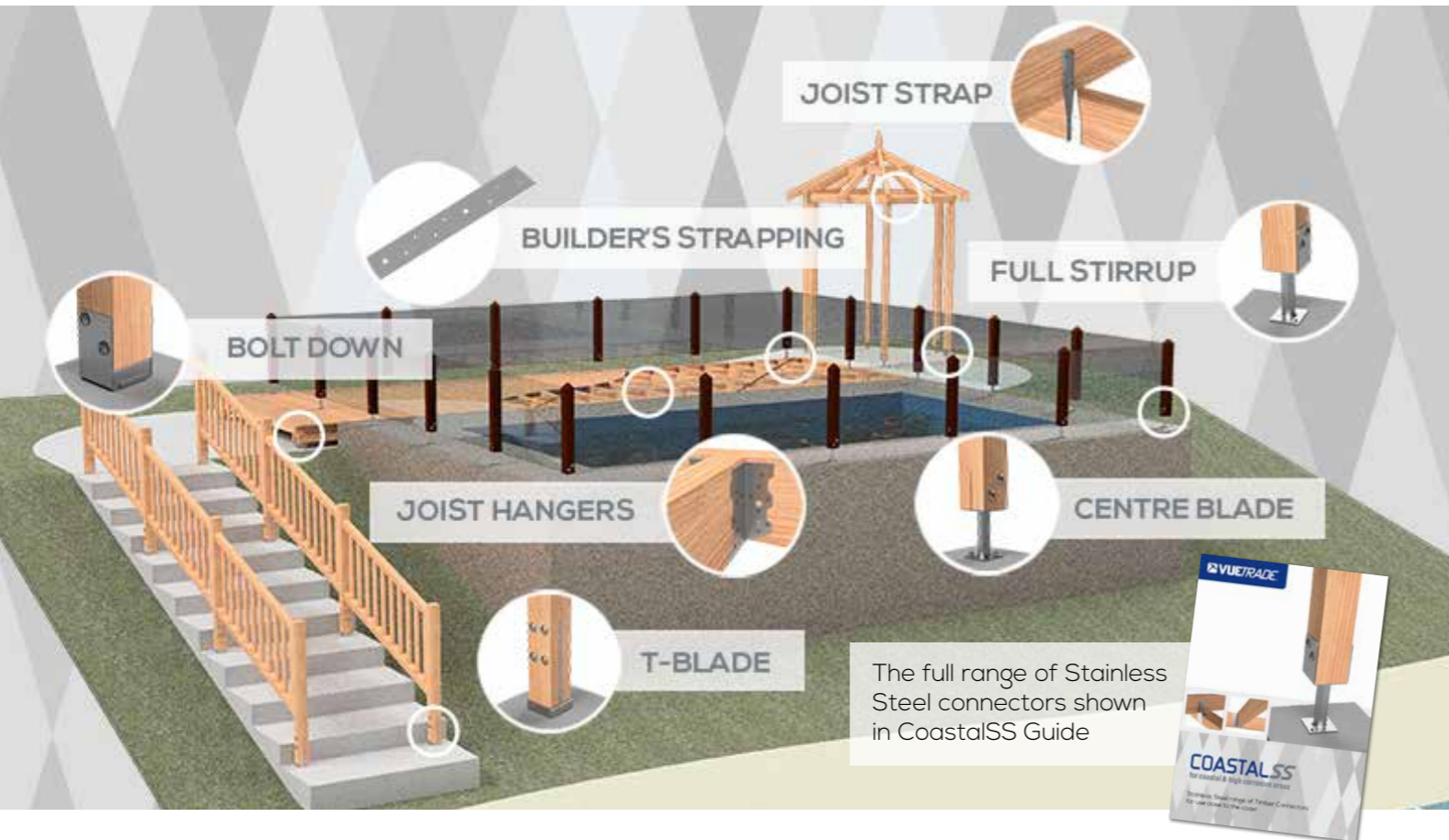

The full range of Stainless Steel connectors shown in CoastalSS Guide



Punched Builder's Strapping

Stainless Steel is recommended for increased corrosion resistance in various coastal areas. The Australian Standards provide guidelines for the use of Stainless Steel fixings and brackets.



Above: Examples of corroded timber connectors installed in an area which is classed as Severe Marine.

Further information on [vuetrade.com](http://vuetrade.com)



To locate Stainless Steel products look for the raindrop icon (Stainless Steel 304) or the wave icon (Stainless Steel 316) throughout this guide.



T-Blade



T-Blade



# BLACKOUT

Order Page:



Cyclonic Post Supports



T-Blade & Cap



Cyclonic Post Support



Bolt Down Post Support



Tradies Bolt Down



Full Stirrup Post Support



Joist Hanger



Ultra Heavy Duty Angle



Pergola Angle



Hold Down Bracket



Sub Floor Vent



VUEBOLT

The full range of powder coated connectors shown in the BLACKOUT Guide



Ultra Heavy Duty Angles

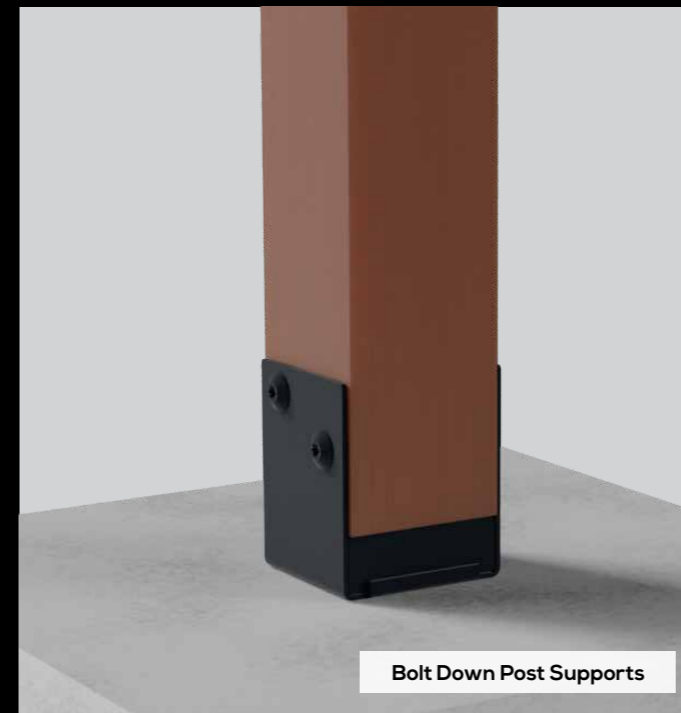

Bolt Down Post Supports

## Outstanding - without standing out!

Our new BLACKOUT powder coated range utilises our industry proven timber connectors and coats them for a superior matte black finish for your timber project.

Along with all our other VUETRADE products, they go through our strict quality control procedures to ensure that when on-site you are not disappointed or non-compliant.

## Matte, non-gloss finish

Based on local market research, numerous conversations with on-the-ground stakeholders and trending external projects we have created the matte black, non-gloss BLACKOUT powder coated finish.

It is designed for maximum longevity and to complement a wider range of timber hues, with the confidence of our existing unchanged design of VUETRADE timber connectors.



T-Blade



Joist Hanger



VUEBOLT





# Product Guide

## Guide tips and useful information:

Find more product information in this booklet following this page reference.

See Page 8

The full range of materials available for each product is marked in this top-right key.

Find more product info online following this web address.

For more info: [vuetrade.com/abmn](http://vuetrade.com/abmn)

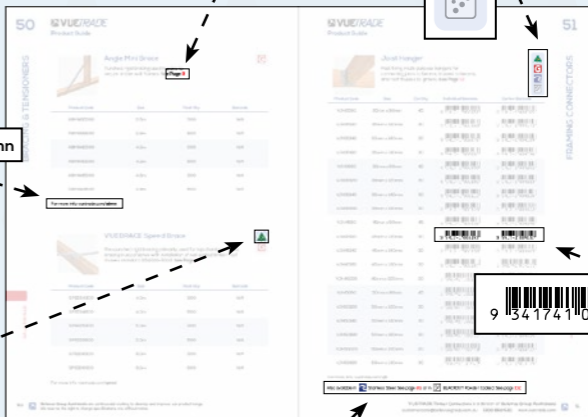

- Galvanised
- 304 Stainless Steel
- 316 Stainless Steel
- BLACKOUT



Individual and Carton barcodes.



Australian Made products are highlighted with this icon for quick and accurate recognition.

Also available in Stainless Steel. See page 83; or in BLACKOUT Powder Coated. See page 102.

Other material barcodes and size availabilities are found through these page references.

# PRODUCT TESTING

At VUETRADE, we have our own product testing facility, run by our in-house engineering team.

This facility ensures quality product development and allows us to continually test our products to guarantee we're delivering consistent quality and provide reliable technical data.

Technical data sheets are available for each product through our website [vuetrade.com](http://vuetrade.com)

All product tests are run according to the relevant Australian Standards at our testing facility on our MTS-SAN Universal Tensile Testing Machine. This machine is calibrated regularly according to NATA requirements, and allows us to confidently provide reliable technical data for all our customers through regular testing.

New and updated VUETRADE products are tested by our technical team to make sure each product meets the required standards and is safe for public use.



Compliance Resources on [vuetrade.com](http://vuetrade.com)



The VUETRADE Compliance Guide is a digital and printed resource that has collated the technical data sheets of the full range of timber connectors, from the Angle Brace to the Z-Type Bracket.

The latest Compliance Guide is available to download online.

It makes it easier to access information on-site or in the office.

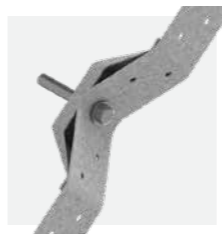

## VUESMART Strap Brace Tensioners

Used to quickly and easily tension VUEBRACE Punched Builder's Strapping after it has been installed on wall or roof framing. See Page 8

Product Code	Pack Size	Ctn Qty	Individual Barcode	Carton Barcode
VUESMART	Pack of 6 tensioners	25		
VUESMARTBULK	Pack of 10 tensioners	15		

For more info: [vuetrade.com/vuesmart](http://vuetrade.com/vuesmart)



GALVANISED

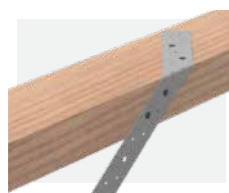

### VUEBRACE Punched Builder's Strapping

Galvanised tension bracing ideal for bracing roofs, walls, ceilings and floors. **See Page 8**



Product Code	Size	kN Capacity	Pkt Qty	Barcode
VB3086	30mm x 0.8mm x 6mt	6.3 kN	360	9 341741 003518
VB30815	30mm x 0.8mm x 15mt	6.3 kN	360	9 341741 003495
VB30830	30mm x 0.8mm x 30mt	6.3 kN	200	9 341741 002719
VB30850	30mm x 0.8mm x 50mt	6.3 kN	112	9 341741 003501
VB3016	30mm x 1.0mm x 6mt	8.6 kN	360	9 341741 003556
VB30115	30mm x 1.0mm x 15mt	8.6 kN	360	9 341741 003525
VB30130	30mm x 1.0mm x 30mt	8.6 kN	150	9 341741 003532
VB30150	30mm x 1.0mm x 50mt	8.6 kN	96	9 341741 003549
VB301230	30mm x 1.2mm x 30mt	11.2 kN	128	9 341741 010325
VB301250	30mm x 1.2mm x 50mt	11.2 kN	72	9 341741 010417

For more info: [vuetrade.com/vb](http://vuetrade.com/vb) Also available in Stainless Steel. See page 82.



### VUEBRACE Light Duty Strapping

Galvanised tension bracing for use in light duty applications where there are no heavy loads or wind uplifts to bear. **See Page 9**



Product Code	Size	Pkt Qty	Barcode
VB2566	25mm x 0.6mm x 6mt	360	9 341741 003464
VB25615	25mm x 0.6mm x 15mt	360	9 341741 003440
VB25630	25mm x 0.6mm x 30mt	200	9 341741 003457
VB25815	25mm x 0.8mm x 15mt	360	9 341741 003471
VB25830	25mm x 0.8mm x 30mt	200	9 341741 003488

For more info: [vuetrade.com/vb25](http://vuetrade.com/vb25)

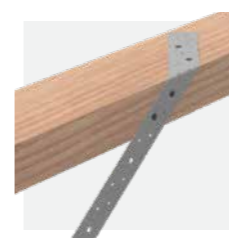

### Punched Builder's Strapping Strips

Galvanised tension bracing used to brace roofs, walls, ceilings and floors, supplied in pre-cut lengths for your convenience. **See Page 8**



Product Code	Size	Pack Qty	Barcode
VB308315	30mm x 0.8mm x 3.15mt	500	N/A
VB301315	30mm x 1.0mm x 3.15mt	500	N/A
VB30836	30mm x 0.8mm x 3.6mt	500	9 341741 015207
VB30136	30mm x 1.0mm x 3.6mt	500	9 341741 015191
VB30842	30mm x 0.8mm x 4.2mt	500	N/A
VB30142	30mm x 1.0mm x 4.2mt	500	N/A

For more info: [vuetrade.com/vb-strips](http://vuetrade.com/vb-strips)



### VUEBRACE Unpunched Builder's Strapping

Galvanised tension bracing without pre-punched holes, suitable for general bracing and strapping, including in carport and pergola construction. **See Page 9**



Product Code	Size	Ctn Qty	Barcode
VB30830UP	30mm x 0.8mm x 30mt	1	9 341741 014965
VB301230UP	30mm x 1.2mm x 30mt	1	9 341741 013869
VB301250UP	30mm x 1.2mm x 50mt	1	9 341741 018604
VB321230UP	32mm x 1.2mm x 30mt	1	9 341741 014613
VB321250UP	32mm x 1.2mm x 50mt	1	9 341741 014620

For more info: [vuetrade.com/vb-up](http://vuetrade.com/vb-up)



### Angle Mini Brace

Punched, rigid bracing used in pairs to secure timber wall frames. **See Page 9**



Product Code	Size	Pack Qty	Barcode
ABMN36300	3.6m	300	N/A
ABMN36600	3.6m	600	N/A
ABMN42300	4.2m	300	N/A
ABMN42600	4.2m	600	N/A
ABMN48300	4.8m	300	N/A
ABMN48600	4.8m	600	N/A

For more info: [vuetrade.com/abmn](http://vuetrade.com/abmn)



### VUEBRACE Speed Brace

Pre-punched rigid bracing primarily used for top chord roof truss bracing in accordance with installation of nail-plated timber roof trusses standard AS4440-2004. **See Page 9**



Product Code	Size	Pack Qty	Barcode
SPEED4300	4.0m	300	N/A
SPEED4600	4.0m	600	N/A
SPEED5300	5.0m	300	N/A
SPEED5600	5.0m	600	N/A
SPEED6300	6.0m	300	N/A
SPEED6600	6.0m	600	N/A

For more info: [vuetrade.com/speed](http://vuetrade.com/speed)

GALVANISED



### Joist Hanger

Fast fixing, multi-purpose hangers for connecting joists to beams, trusses to girders, and roof trusses to girders. **See Page 12**



Product Code	Size	Ctn Qty	Individual Barcode	Carton Barcode
VJH3590	35mm x 90mm	45	9 34 174 1 003051	9 34 174 1 004065
VJH35120	35mm x 120mm	30	9 34 174 1 003068	9 34 174 1 004072
VJH35140	35mm x 140mm	30	9 34 174 1 003075	9 34 174 1 004089
VJH35180	35mm x 180mm	30	9 34 174 1 003082	9 34 174 1 004096
VJH3890	38mm x 90mm	45	9 34 174 1 003099	9 34 174 1 004102
VJH38120	38mm x 120mm	30	9 34 174 1 003105	9 34 174 1 004119
VJH38140	38mm x 140mm	30	9 34 174 1 003112	9 34 174 1 004126
VJH38180	38mm x 180mm	30	9 34 174 1 003129	9 34 174 1 004133
VJH4590	45mm x 90mm	45	9 34 174 1 003136	9 34 174 1 004140
VJH45120	45mm x 120mm	30	9 34 174 1 003143	9 34 174 1 004157
VJH45140	45mm x 140mm	30	9 34 174 1 003150	9 34 174 1 004164
VJH45180	45mm x 180mm	30	9 34 174 1 003167	9 34 174 1 004171
VJH45220	45mm x 220mm	20	9 34 174 1 003174	9 34 174 1 004188
VJH5090	50mm x 90mm	45	9 34 174 1 003181	9 34 174 1 004195
VJH50120	50mm x 120mm	30	9 34 174 1 003198	9 34 174 1 004201
VJH50140	50mm x 140mm	30	9 34 174 1 003204	9 34 174 1 004218
VJH50180	50mm x 180mm	30	9 34 174 1 003211	9 34 174 1 004225
VJH50220	50mm x 220mm	20	9 34 174 1 003228	9 34 174 1 004232
VJH58180	58mm x 180mm	30	9 34 174 1 014422	9 34 174 1 014439

For more info: [vuetrade.com/vjh](http://vuetrade.com/vjh)

Also available in Stainless Steel. See page 83; or in BLACKOUT Powder Coated. See page 102.

GALVANISED



### Split Joist Hangers

Fast fixing, multi-purpose hangers for joist, beam and truss connections where timber is over the width of 50mm. **See Page 12**



Product Code	Size	Ctn Qty	Individual Barcode	Carton Barcode
VSJH120	120mm	30		
VSJH140	140mm	30		
VSJH180	180mm	30		
VSJH220	220mm	20		

For more info: [vuetrade.com/vsjh](http://vuetrade.com/vsjh) Also available in Stainless Steel. See page 84.



To find locally made timber connectors, look for the green and gold kangaroo.

See our full Australian Made connectors range online: [vuetrade.com/products-au](http://vuetrade.com/products-au)



### I-Beam Hanger

Multi-purpose hanger brackets for securely connecting I-beams and large joists to framing structures. **See Page 12**



Product Code	Size	Ctn Qty	Individual Barcode	Carton Barcode
VIBHF40240	40mm x 240mm	20		
VIBHF40300	40mm x 300mm	20		
VIBHF45200	45mm x 200mm	20		
VIBHF45240	45mm x 240mm	20		
VIBHF45300	45mm x 300mm	20		
VIBHF51240	51mm x 240mm	20		
VIBHF51300	51mm x 300mm	20		
VIBHF63200	63mm x 200mm	20		
VIBHF63240	63mm x 240mm	20		
VIBHF63300	63mm x 300mm	20		
VIBHF70240	70mm x 240mm	20		
VIBHF70300	70mm x 300mm	20		
VIBHF90200	90mm x 200mm	20		
VIBHF90240	90mm x 240mm	20		
VIBHF90300	90mm x 300mm	20		
VIBHF90360	90mm x 360mm	20		
VIBHF90400	90mm x 400mm	20		

For more info: [vuetrade.com/vibhf](http://vuetrade.com/vibhf)





**Triple Grip**

Multipurpose galvanised building brackets ideal for many nail-fixed timber joints with perpendicular angles. **See Page 14**



Product Code	Size	Ctn Qty	Individual Barcode	Carton Barcode
VTTGLH	LEFT HAND	100	9 34 174 1 003303	9 34 174 1 004317
VTTGRH	RIGHT HAND	100	9 34 174 1 003310	9 34 174 1 004324

For more info: [vuetrade.com/vttg](http://vuetrade.com/vttg) Also available in Stainless Steel. See page 84.



**Mini Grip**

Multipurpose timber framing brackets ideal for joining timber at right angles. **See Page 14**



Product Code	Size	Ctn Qty	Individual Barcode	Carton Barcode
VTMG57	57mm	200	9 34 174 1 004256	9 34 174 1 004263

For more info: [vuetrade.com/vtmg57](http://vuetrade.com/vtmg57) Also available in Stainless Steel. See page 84.



**Multi Grip**

Versatile, cost-effective brackets used for right angle joints in timber framing. **See Page 14**



Product Code	Size	Ctn Qty	Individual Barcode	Carton Barcode
VTMG100	100mm	200	9 34 174 1 003266	9 34 174 1 004270
VTMG115	115mm	100	9 34 174 1 003273	9 34 174 1 004287

For more info: [vuetrade.com/vtmg](http://vuetrade.com/vtmg) Also available in Stainless Steel. See page 85.



**Joist Strap**

Easy to use connectors ideal for fixing ceiling joists or rafters to hanging beams. **See Page 13**



Product Code	Size	Ctn Qty	Individual Barcode	Carton Barcode
VTJS150	175mm LONG	150	9 34 174 1 003242	9 34 174 1 003259

For more info: [vuetrade.com/vtjs](http://vuetrade.com/vtjs) Also available in Stainless Steel. See page 85.



**Heavy Duty Joist Strap**

Brackets used in load-bearing timber framing applications such as connecting floor joists to bearers. **See Page 13**



Product Code	Size	Description	Ctn Qty	Individual Barcode	Carton Barcode
VTHDJL	31mm x 170mm	LEFT HAND	200	9 34 174 1 003679	9 34 174 1 004560
VTHDJR	31mm x 170mm	RIGHT HAND	200	9 34 174 1 003686	9 34 174 1 004577

For more info: [vuetrade.com/vthdj](http://vuetrade.com/vthdj)



**Cyclone Strap**

Tie-downs ideal for cyclonic and high wind areas. **See Page 17**



Product Code	Size	Box Qty	Individual Barcode	Carton Barcode
VTCS400	400mm	100	9 34 174 1 003648	9 34 174 1 004539
VTCS600	600mm	100	9 34 174 1 003655	9 34 174 1 004546
VTCS900	900mm	100	9 34 174 1 003662	9 34 174 1 004553

For more info: [vuetrade.com/vtcs](http://vuetrade.com/vtcs)



### Stud Tie

Easy install fasteners ideal for jointing top and bottom wall plates to studs. **See Page 15**



Product Code	Size	Ctn Qty	Individual Barcode	Carton Barcode
VTST4U90	150mm x 90mm x 150mm	50		

For more info: [vuetrade.com/vtst4u90](http://vuetrade.com/vtst4u90)



### Single Sided Stud Tie

Brackets ideal for fastening top and bottom wall plates to studs in high wind areas. **See Page 15**



Product Code	Size	Description	Ctn Qty	Individual Barcode	Carton Barcode
VTSTLH	240mm x 60mm x 32mm	Left Hand	75		
VTSTRH	240mm x 60mm x 32mm	Right Hand	75		

For more info: [vuetrade.com/vtst](http://vuetrade.com/vtst)



### Insul Fix Fasteners

Provide a strong and rip-free fixing for foil insulation. **See Page 16**



Product Code	Ctn Qty	Barcode
F81006	500	N/A

For more info: [vuetrade.com/f81006](http://vuetrade.com/f81006)



### Strap Nails

Tap-in nail plates ideal for quick jointing of timber frames. **See Page 17**



Product Code	Size	Box Qty	Individual Barcode	Carton Barcode
VTSN2590	25mm x 90mm	100		
VTSN5090	50mm x 90mm	100		
VTSN7590	75mm x 90mm	100		

For more info: [vuetrade.com/vtsn](http://vuetrade.com/vtsn)



### Foil Tacks

A non-tear fixing ideal for sheet and foil insulation. **See Page 16**



Product Code	Box Qty	Individual Barcode	Carton Barcode
VTFT	500		

For more info: [vuetrade.com/vtft](http://vuetrade.com/vtft)



**Tap in Plate**

Timesaving nail plates with built-in steel 'teeth', ideal for joining timber wall frames and top plates.  
**See Page 17**



Product Code	Size	Ctn Qty	Individual Barcode	Carton Barcode
VTIP45120	45mm x 120mm	100		
VTIP45180	45mm x 180mm	67		
VTIP45240	45mm x 240mm	50		
VTIP7060	70mm x 60mm	100		
VTIP70120	70mm x 120mm	75		
VTIP70180	70mm x 180mm	50		
VTIP70240	70mm x 240mm	38		
VTIP70300	70mm x 300mm	30		
VTIP90120	90mm x 120mm	50		
VTIP90180	90mm x 180mm	34		
VTIP90240	90mm x 240mm	25		
VTIP90300	90mm x 300mm	20		
VTIP130120	130mm x 120mm	30		
VTIP130180	130mm x 180mm	20		

For more info: [vuetrade.com/vtip](http://vuetrade.com/vtip) Also available in Stainless Steel. See page 85.



**Connector Plate Nails 30mm x 2.8mm**

Hot-dipped galvanised fixings specifically for fixing applications using any VUETRADE timber connector. **See Page 16**



Product Code	Size	Barcode
VTCPNG3028500	500g	
VTCPNG30282	2kg	
VTCPNG30285	5kg	

For more info: [vuetrade.com/vtcpng](http://vuetrade.com/vtcpng) Also available in Stainless Steel. See page 86.



**Connector Plate Nails - 33mm x 3.15mm**

Hot-dipped galvanised fixings specifically for fixing applications using the VUETRADE I-Beam Hangers. **See Page 16**



Product Code	Size	Barcode
VTCPNG333151	1kg	

For more info: [vuetrade.com/vtcpng33315](http://vuetrade.com/vtcpng33315)



**Connector Plate Screws**

Fixings designed to suit VUETRADE timber connectors. **See Page 16**



Product Code	Description	Pack Qty	Barcode
VTCP35-100	5/16" HEX DRIVE x 35mm	100	
VTCP35-250	5/16" HEX DRIVE x 35mm	250	
VTCP65-100	5/16" HEX DRIVE x 65mm	100	
VTCP65-250	5/16" HEX DRIVE x 65mm	250	

For more info: [vuetrade.com/vtcp35](http://vuetrade.com/vtcp35) Also available in Stainless Steel. See page 86.



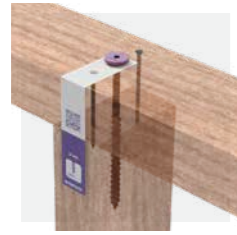

### VUEFIX Stud-Smart Screws

Fixings used to secure single and double top plates to timber studs and are a compliant replacement for stud strapping. **See Page 15**



Product Code	Length	Ctn Qty	Carton Barcode
ST140RP	140mm (Purple)	50	9 34 174 1 02 1260
ST140TP	140mm (Purple)	250	9 34 174 1 02 1598
ST185RP	185mm (Orange)	50	9 34 174 1 02 1277
ST185TP	185mm (Orange)	250	9 34 174 1 02 1604

For more info: [vuetrade.com/stud-smart](http://vuetrade.com/stud-smart)

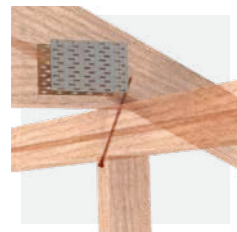

### VUEFIX Truss-Screws

Secure timber trusses and rafters without the need of securing with cyclone straps or other similar products. **See Page 17**



Product Code	Length	Ctn Qty	Carton Barcode
TS150TP	150mm	50	9 34 174 1 02 3073

For more info: [vuetrade.com/ts150](http://vuetrade.com/ts150)



### Bearer Plates

Nail on plate timber connector suitable for joining timber, framework repair and reinforcement. **See Page 20**



Product Code	Size	Ctn Qty	Individual Barcode	Carton Barcode
VTBP80120	80mm x 120mm	100	9 34 174 1 01 4637	9 34 174 1 01 4644
VTBP80180	80mm x 180mm	100	9 34 174 1 00 3747	9 34 174 1 00 4607
VTBP80240	80mm x 240mm	50	9 34 174 1 01 4651	9 34 174 1 01 4668
VTBP80300	80mm x 300mm	50	9 34 174 1 01 4675	9 34 174 1 01 4682

For more info: [vuetrade.com/vtbp](http://vuetrade.com/vtbp) Also available in Stainless Steel. See page 87.



### Pergola Angles

Galvanised, multi-purpose building brackets ideal for connecting pergola rafters to beams. **See Page 20**



Product Code	Size	Ctn Qty	Individual Barcode	Carton Barcode
VTPA36	92mm x 68mm x 36mm x 1.6mm	200	9 34 174 1 00 3280	9 34 174 1 00 4294

For more info: [vuetrade.com/vtpa36](http://vuetrade.com/vtpa36) Also available in Stainless Steel. See page 87.



### Internal Wall Brackets

Pre-punched galvanised steel brackets ideal for fixing walls to trusses. **See Page 20**



Product Code	Size	Ctn Qty	Individual Barcode	Carton Barcode
VTPA47	127mm x 55mm x 47mm x 1.5mm	100	9 34 174 1 00 3235	9 34 174 1 00 4249

For more info: [vuetrade.com/vtpa47](http://vuetrade.com/vtpa47)



### Hold Down Brackets

Galvanised building brackets typically used in the construction of wall studs and roof trusses. **See Page 20**



Product Code	Size	Ctn Qty	Individual Barcode	Carton Barcode
VTHDB	120mm x 50mm x 47mm x 2.0mm	75	9 341741 007813	9 341741 007820

For more info: [vuetrade.com/vthdb](http://vuetrade.com/vthdb) Also available in Stainless Steel. See page 88.



### Ultra Heavy Duty Angles

Multi-purpose right-angled brackets ideal for framing staircases. **See Page 21**



Product Code	Size	Ctn Qty	Individual Barcode	Carton Barcode
VTUHDA4040	40mm x 40mm x 230mm	40	9 341741 003327	9 341741 004331

For more info: [vuetrade.com/vtuhda](http://vuetrade.com/vtuhda)

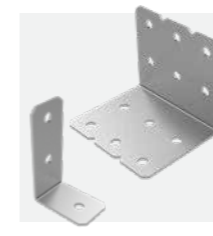

### Angle Brackets - Heavy Duty

Multi-purpose right-angled brackets ideal for right angle applications. **See Page 22**



Product Code	Description	Size	Ctn Qty	Individual Barcode	Carton Barcode
VABHD01	40L x 60W x 60H x 3.0mm	M10	50	9 341741 019595	9 341741 019601
VABHD02	40L x 60W x 100H x 3.0mm	M10	50	9 341741 019618	9 341741 019625
VABHD03	40L x 100W x 100H x 3.0mm	M10	50	9 341741 019632	9 341741 019649
VABHD04	80L x 60W x 60H x 3.0mm	M10	50	9 341741 019656	9 341741 019663
VABHD05	80L x 60W x 100H x 3.0mm	M10	25	9 341741 019670	9 341741 019687
VABHD06	80L x 100W x 100H x 3.0mm	M10	25	9 341741 019694	9 341741 019700
VABHD07	120L x 60W x 60H x 3.0mm	M10	25	9 341741 019717	9 341741 019724
VABHD08	120L x 60W x 100H x 3.0mm	M10	25	9 341741 009879	9 341741 009886
VABHD09	120L x 100W x 100H x 3.0mm	M10	20	9 341741 019731	9 341741 019748
VABHD10	160L x 60W x 60H x 3.0mm	M10	25	9 341741 019755	9 341741 019762
VABHD11	160L x 60W x 100H x 3.0mm	M10	20	9 341741 019779	9 341741 019786
VABHD12	160L x 100L x 100W x 3.0mm	M10	20	9 341741 019793	9 341741 019809

For more info: [vuetrade.com/vabhd](http://vuetrade.com/vabhd) Also available in Stainless Steel. See page 88.



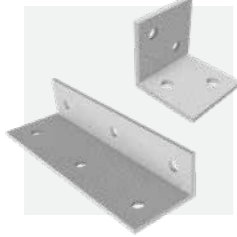

### Structural HDG Brackets

Equal right-angled brackets ideal for structural capacity connections. See Page 21



Product Code	Description	Size	Ctn Qty	Individual Barcode	Carton Barcode
VABHS01G	75L x 75W x 75H x 6.0mm	M12	10		
VABHS02G	100L x 100W x 100H x 6.0mm	M12	10		
VABHS03G	185L x 100W x 100H x 6.0mm	M12	10		
VABHS04G	250L x 100W x 100H x 6.0mm	M12	6		
VABHS05G	150L x 100W x 100H x 8.0mm	M16	6		
VABHS06G	200L x 100W x 100H x 8.0mm	M16	6		
VABHS07G	200L x 140W x 90H x 8.0mm	M16	6		
VABHS08G	140L x 65W x 65H x 5.0mm	M12	10		
VABHS09G	190L x 65W x 65H x 5.0mm	M12	10		
VABHS10G	240L x 65W x 65H x 5.0mm	M12	10		
VABHS11G	290L x 65W x 65H x 5.0mm	M12	10		
VABHS12G	140L x 75W x 50H x 5.0mm Unequal	M12	10		
VABHS13G	190L x 75W x 50H x 5.0mm Unequal	M12	10		
VABHS14G	240L x 75W x 50H x 5.0mm Unequal	M12	10		
VABHS15G	290L x 75W x 50H x 5.0mm Unequal	M12	10		

For more info: [vuetrade.com/vabhs](http://vuetrade.com/vabhs)



### L Type HDG Bracket

Multi-purpose right-angled brackets suited for outdoor environments, corrosion protected by hot dipped galvanised. See Page 21



Product Code	Description	Size	Ctn Qty	Individual Barcode	Carton Barcode
VABL01G	40L x 40W x 40H x 5.0mm	M10	50		
VABL02G	40L x 40W x 40H x 5.0mm	M12	50		
VABL03G	50L x 50W x 50H x 5.0mm	M12	50		
VABL04G	65L x 65W x 65H x 5.0mm	M12	25		
VABL05G	75L x 90W x 90H x 6.5mm	M12	10		
VABL06G	40L x 40W x 80H x 5.0mm	M12	50		
VABL07G	50L x 50W x 100H x 5.0mm	M12	25		
VABL08G	65L x 65W x 130H x 5.0mm	M12	20		
VABL09G	75L x 90W x 150H x 6.5mm	M12	10		
VABL10G	40L x 80W x 80H x 5.0mm	M12	25		
VABL11G	50L x 100W x 100H x 5.0mm	M12	25		
VABL12G	65L x 130W x 130H x 5.0mm	M12	10		
VABL13G	75L x 150W x 150H x 6.5mm	M12	10		

For more info: [vuetrade.com/vabl](http://vuetrade.com/vabl)

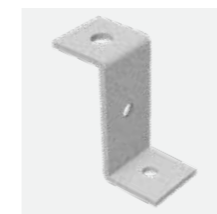

### Z Type HDG Bracket

Multi-purpose Z-angled brackets ideal for tie-down applications. See Page 22



Product Code	Description	Ctn Qty	Individual Barcode	Carton Barcode
VBZG	50mm x 105mm x 50mm x 5.0mm	25		

For more info: [vuetrade.com/vbzig](http://vuetrade.com/vbzig)

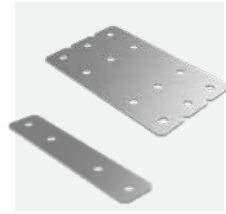

### Plates - Heavy Duty

Allows for connection between flat timber faces. **See Page 22**



Product Code	Description	Size	Ctn Qty	Individual Barcode	Carton Barcode
VPHD12040	120mm x 40mm x 3.0mm	M10	50		
VPHD12080	120mm x 80mm x 3.0mm	M10	25		
VPHD120120	120mm x 120mm x 3.0mm	M10	25		
VPHD120160	120mm x 160mm x 3.0mm	M10	25		
VPHD16040	160mm x 40mm x 3.0mm	M10	50		
VPHD16080	160mm x 80mm x 3.0mm	M10	25		
VPHD160120	160mm x 120mm x 3.0mm	M10	25		
VPHD160160	160mm x 160mm x 3.0mm	M10	25		
VPHD20040	200mm x 40mm x 3.0mm	M10	50		
VPHD20080	200mm x 80mm x 3.0mm	M10	25		
VPHD200120	200mm x 120mm x 3.0mm	M10	20		
VPHD200160	200mm x 160mm x 3.0mm	M10	15		

For more info: [vuetrade.com/vphd](http://vuetrade.com/vphd) Also available in  Stainless Steel. See page 89.



### Fascia Brackets

Hot dipped galvanised angled brackets for secure fascia to rafter or truss connections. **See Page 22**



Product Code	Angle	Neck Length	Ctn Qty	Individual Barcode	Carton Barcode
VTHDFB05	5°	150mm	6		
VTHDFB12	12°	150mm	6		
VTHDFB17	17°	150mm	6		
VTHDFB22	22°	150mm	6		
VTHDFB28	28°	150mm	6		
VTHDFB35	35°	150mm	6		
VTHDFB17L	17°	220mm	6		
VTHDFB22L	22°	220mm	6		
VTHDFB28L	28°	220mm	6		

For more info: [vuetrade.com/vthdf](http://vuetrade.com/vthdf)



### I-Beam Variable Skew Angle

Universal connector commonly used for timber truss connections where beams or trusses are coming in at an angle to the beam or girder truss. **See Page 23**



Product Code	Dimensions	Ctn Qty	Individual Barcode	Carton Barcode
VIBVSA150	150 x 50 x 75mm	10		
VIBVSA300	300 x 50 x 75mm	10		

For more info: [vuetrade.com/vibvsa](http://vuetrade.com/vibvsa)





**Full Stirrup Post Supports**

Brackets ideal for holding timber posts, installed by bolting onto or setting into concrete. **See Page 35**



Product Code	Size	Ctn Qty	Individual Barcode	Carton Barcode
VPS7590	75mm x 90mm	10	9 34 174 1 006588	9 34 174 1 007073
VPS13090	130mm x 90mm	10	9 34 174 1 002498	9 34 174 1 006618
VPS15090	150mm x 90mm	10	9 34 174 1 006342	9 34 174 1 006830
VPS20090	200mm x 90mm	10	9 34 174 1 002511	9 34 174 1 006632
VPS25090	250mm x 90mm	10	9 34 174 1 006502	9 34 174 1 006991
VPS30090	300mm x 90mm	10	9 34 174 1 002535	9 34 174 1 006656
VPS37590	375mm x 90mm	10	9 34 174 1 006526	9 34 174 1 007011
VPS45090	450mm x 90mm	10	9 34 174 1 006540	9 34 174 1 007035
VPS60090	600mm x 90mm	10	9 34 174 1 006564	9 34 174 1 007059
VPS75100	75mm x 100mm	10	9 34 174 1 006571	9 34 174 1 007066
VPS130100	130mm x 100mm	10	9 34 174 1 002504	9 34 174 1 006625
VPS150100	150mm x 100mm	10	9 34 174 1 006304	9 34 174 1 006793
VPS200100	200mm x 100mm	10	9 34 174 1 002528	9 34 174 1 006649
VPS250100	250mm x 100mm	10	9 34 174 1 006496	9 34 174 1 006984
VPS300100	300mm x 100mm	10	9 34 174 1 002542	9 34 174 1 006663
VPS375100	375mm x 100mm	10	9 34 174 1 006519	9 34 174 1 007004
VPS450100	450mm x 100mm	10	9 34 174 1 006533	9 34 174 1 007028
VPS600100	600mm x 100mm	10	9 34 174 1 006557	9 34 174 1 007042

GALVANISED

**Full Stirrup Post Supports c'td**

Product Code	Size	Ctn Qty	Individual Barcode	Carton Barcode
VPS130115	130mm x 115mm	10	9 34 174 1 009145	9 34 174 1 009152
VPS300115	300mm x 115mm	10	9 34 174 1 009169	9 34 174 1 009176
VPS450115	450mm x 115mm	10	9 34 174 1 006380	9 34 174 1 006878
VPS600115	600mm x 115mm	10	9 34 174 1 009183	9 34 174 1 009190
VPS150120	150mm x 120mm	10	9 34 174 1 006311	9 34 174 1 006809
VPS300120	300mm x 120mm	10	9 34 174 1 006359	9 34 174 1 006847
VPS130125	130mm x 125mm	10	9 34 174 1 006298	9 34 174 1 006786
VPS150125	150mm x 125mm	10	9 34 174 1 006328	9 34 174 1 006816
VPS300125	300mm x 125mm	10	9 34 174 1 006366	9 34 174 1 006854
VPS450125	450mm x 125mm	10	9 34 174 1 010332	9 34 174 1 010349
VPS130135	130mm x 135mm	10	9 34 174 1 018086	9 34 174 1 018093
VPS300135	300mm x 135mm	10	9 34 174 1 010424	9 34 174 1 010431
VPS450135	450mm x 135mm	10	9 34 174 1 010356	9 34 174 1 010363
VPS300140	300mm x 140mm	10	9 34 174 1 015221	9 34 174 1 015238
VPS150150	150mm x 150mm	10	9 34 174 1 006335	9 34 174 1 006823
VPS300150	300mm x 150mm	10	9 34 174 1 006373	9 34 174 1 006861
VPS450150	450mm x 150mm	10	9 34 174 1 010370	9 34 174 1 010387

For more info: [vuetrade.com/vps](http://vuetrade.com/vps)

Also available in Stainless Steel. See page 90; or in BLACKOUT Powder Coated. See page 102.



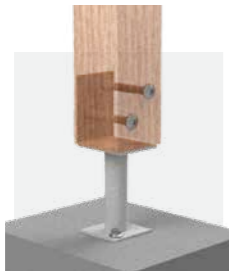





GALVANISED



### Half Stirrup Post Supports

Brackets ideal for fixing timber posts to a base, especially where the post can only be accessed from one side for bolting. **See Page 35**



Product Code	Size	Ctn Qty	Individual Barcode	Carton Barcode
VHSPS75	75mm	10		
VHSPS125	125mm	10		
VHSPS200	200mm	10		
VHSPS250	250mm	10		
VHSPS300	300mm	10		





For more info: [vuetrade.com/vhsp](http://vuetrade.com/vhsp) Also available in   Stainless Steel. See page 92.



### Centre Blade Post Supports

Brackets used for fixing timber posts to concrete or timber bases, with the 'hidden' blade providing a neat finish. **See Page 33**



Product Code	Description	Ctn Qty	Individual Barcode	Carton Barcode
VBLPS125	125mm	10		
VBLPS300	300mm	10		



For more info: [vuetrade.com/vblps](http://vuetrade.com/vblps) Also available in   Stainless Steel. See page 92.



### Concealed Bolt Down Post Support Kit

System ideal for fixing decorative timber posts with an architectural, concealed finish. **See Page 33**



Product Code	Size	Ctn Qty	Individual Barcode	Carton Barcode
VCBPS90	90mm	10		







For more info: [vuetrade.com/vcbps](http://vuetrade.com/vcbps)

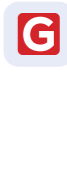

### Pin Shaft Post Supports

Brackets ideal for holding timber posts in applications where the post support needs to be totally concealed. **See Page 35**



Product Code	Size	Ctn Qty	Individual Barcode	Carton Barcode
VPPS125	125mm	10		
VPPS200	200mm	10		
VPPS300	300mm	10		





For more info: [vuetrade.com/vpps](http://vuetrade.com/vpps)



### Adjustable Post Supports

Brackets ideal for fixing uncommon or large sizes of timber posts, installed by bolting onto concrete. **See Page 33**



Product Code	Size	Ctn Qty	Individual Barcode	Carton Barcode
VAPS75	75mm	10		
VAPS160	160mm	10		

For more info: [vuetrade.com/vaps](http://vuetrade.com/vaps)



### Tradies' Bolt Down Post Support

Brackets ideal for bolting down timber posts, with either an open or concealed assembly. **See Page 34**



Product Code	Size	Ctn Qty	Individual Barcode	Carton Barcode
VTBPS90	90mm	20		

For more info: [vuetrade.com/vtbps](http://vuetrade.com/vtbps)





### Bolt Down Post Support

Connectors ideal for strong, concealed bolting of timber posts onto concrete bases.  
**See Page 34**



Product Code	Size	Ctn Qty	Individual Barcode	Carton Barcode
VBPS90	90mm	10		
VBPS100	100mm	10		
VBPS115	115mm	10		
VBPS125	125mm	10		

For more info: [vuetrade.com/vbps](http://vuetrade.com/vbps)

Also available in Stainless Steel. See page 93; or in BLACKOUT Powder Coated. See page 102.



### T-Blade Post Support

Brackets ideal for concealed fixing of large decorative timber posts by bolting onto concrete. **See Page 32**



Product Code	Description	Ctn Qty	Individual Barcode	Carton Barcode
VBPTB90100	80 x 80mm Base - 250mm Blade	6		
VBPTB115140	110 x 110mm Base - 275mm Blade	6		
VBPTB150180	140 x 140mm Base - 300mm Blade	4		
VBPTB180200	180 x 180mm Base - 350mm Blade	2		
VBPTB250350	240 x 240mm Base - 400mm Blade	1		N/A

For more info: [vuetrade.com/vbptb](http://vuetrade.com/vbptb)

Also available in Stainless Steel. See page 94; or in BLACKOUT Powder Coated. See page 102.



### T-Blade Post Support With Leg

Strong, solid connectors ideal for fixing timber posts, by bolting onto or setting into concrete. **See Page 32**



Product Code	Size	Ctn Qty	Barcode
VHDBLPS60080	80 x 80mm Base - 250mm Blade; 600 x 35mm Leg	1	
VHDBLPS600110	110 x 110mm Base - 275mm Blade; 600 x 35mm Leg	1	
VHDBLPS300140SOLID	140 x 140mm Base - 300mm Blade; 300 x 35mm Solid Leg	1	
VHDBLPS600140SOLID	140 x 140mm Base - 300mm Blade; 600 x 35mm Solid Leg	1	
VHDBLPS600180	180 x 180mm Base - 350mm Blade; 600 x 73mm Leg	1	

For more info: [vuetrade.com/vhdblips](http://vuetrade.com/vhdblips) Also available in Stainless Steel. See page 95.

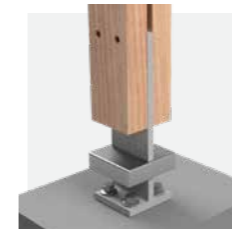

### T-Blade Post Support Cap

316 grade stainless steel concealing caps to suit VUETRADE T-Blade Post Supports, covering base bolts for a neat finish on feature timber posts.



Product Code	Size	Ctn Qty	Individual Barcode	Carton Barcode
VBPTB90100CAP	90 x 90 x 30mm	6		
VBPTB115140CAP	120 x 120 x 30mm	6		
VBPTB150180CAP	150 x 150 x 30mm	4		
VBPTB180200CAP	190 x 190 x 30mm	2		
VBPTB250350CAP	250 x 250 x 30mm	1		N/A

For more info: [vuetrade.com/vbptb-cap](http://vuetrade.com/vbptb-cap) Also available in BLACKOUT Powder Coated. See page 102.





### Ant Caps

Galvanised steel caps ideal for inserting between timber bases and floors in areas with termite activity. **See Page 29**



#### Ant Caps With Hole

Product Code	Size	Ctn Qty	Individual Barcode	Carton Barcode
VAC10025	100 x 100mm - 25mm Flange	50		
VAC10050	100 x 100mm - 50mm Flange	50		
VAC12525	125 x 125mm - 25mm Flange	50		
VAC12550	125 x 125mm - 50mm Flange	50		

#### Ant Caps No Hole

Product Code	Size	Ctn Qty	Individual Barcode	Carton Barcode
VAC10025NH	100 x 100mm - 25mm Flange	50		
VAC10050NH	100 x 100mm - 50mm Flange	50		
VAC12525NH	125 x 125mm - 25mm Flange	50		
VAC12550NH	125 x 125mm - 50mm Flange	50		
VAC23011550NH	230 x 115mm - 50mm Flange	25		
VAC23050NH	230 x 230mm - 50mm Flange	25		

For more info: [vuetrade.com/vac](http://vuetrade.com/vac)



### Ant Caps

Stainless steel caps ideal for inserting between timber bases and floors in coastal areas with termite activity. **See Page 29**



Product Code	Size	Carton Barcode
ANTCAPSS	100 x 100mm - 25mm Flange	

For more info: [vuetrade.com/antcapss](http://vuetrade.com/antcapss)



### Brick Veneer Ties - Light Duty

Masonry wall ties used for providing stability to the brickwork by joining it to timber wall frames by using nails. **See Page 26**



Product Code	Description	Ctn Qty	Individual Barcode	Carton Barcode
VBTLDR2	Light Duty with Nails	150		
VBTLDR3	Light Duty with Nails; SS304	150		
VBTLDR4	Light Duty with Nails; SS316	150		

For more info: [vuetrade.com/vbtld](http://vuetrade.com/vbtld)



### Brick Veneer Ties - Medium Duty

Masonry wall ties used for providing increased stability to the brickwork by joining it to timber wall frames through the use of screws. **See Page 26**



Product Code	Description	Ctn Qty	Individual Barcode	Carton Barcode
VBTMDR2	Medium Duty with Screws	150		
VBTMDR3	Medium Duty with Screws; SS304	150		
VBTMDR4	Medium Duty with Screws; SS316	150		

For more info: [vuetrade.com/vbtmd](http://vuetrade.com/vbtmd)



### Twisted Brick Veneer Ties

Galvanised steel masonry wall ties for fixing brick work to the side of timber framing rather than the face. **See Page 27**



Product Code	Size	Ctn Qty	Individual Barcode	Carton Barcode
VTTWBV	115mm	150		

For more info: [vuetrade.com/vttwbv](http://vuetrade.com/vttwbv)



### Frame Ties



Galvanised masonry wall ties used to tie off brick or block walls to support structures. **See Page 27**



Product Code	Size	Description	Ctn Qty	Individual Barcode	Carton Barcode
VTBTFT	230mm	Z600 Galvanised	150		

For more info: [vuetrade.com/vtbtft](http://vuetrade.com/vtbtft)

### Double Sleeve Expansion Ties

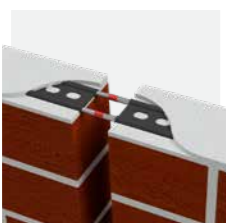

Rod ties designed for vertical masonry expansion joints. **See Page 27**



Product Code	Description	Ctn Qty	Individual Barcode	Carton Barcode
VTDSG	Galvanised	50		

For more info: [vuetrade.com/vtdsg](http://vuetrade.com/vtdsg) Also available in Stainless Steel. See page 97.

### Expansion Ties



Galvanised expansion gap ties designed to stabilise and prevent lateral movement in block masonry joints. **See Page 27**



Product Code	Description	Ctn Qty	Individual Barcode	Carton Barcode
VTEXTG	Galvanised	60		

For more info: [vuetrade.com/vtext](http://vuetrade.com/vtext) Also available in Stainless Steel. See page 97.

### Sub Floor Punched Vents

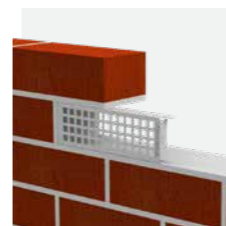

Brick vents designed to combat sub floor moisture, ideal for installation during masonry construction. **See Page 28**



Product Code	Size	Ctn Qty	Individual Barcode	Carton Barcode
VTSFV230X76SLIM	230 x 76mm - Slim	20		
VTSFV230X76	230 x 76mm	20		
VTSFV190X90	190 x 90mm	20		
VTSFV190X190	190 x 190mm	20		
VTSFV230X160	230 x 160mm	20		
VTSFV390X90	390 x 90mm	20		
VTSFV390X190	390 x 190mm	20		

For more info: [vuetrade.com/vtsfv](http://vuetrade.com/vtsfv) Also available in Stainless Steel. See page 98.

### Sub Floor Louvred Vents

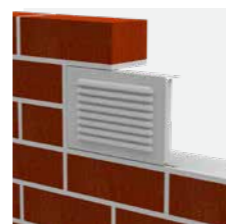

Brick vents designed to combat sub floor dampness, ideal for installation when bricks/blocks are being laid. **See Page 28**



Product Code	Size	Ctn Qty	Individual Barcode	Carton Barcode
VTSFL230X160	230mm x 160mm	10		

For more info: [vuetrade.com/vtsfl](http://vuetrade.com/vtsfl)

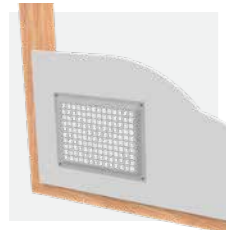

### Flat Face Punched Vents

Brick vents ideal for reducing moisture in structures, designed to be fastened to the face of the wall with screws. **See Page 29**



Product Code	Size	Ctn Qty	Individual Barcode	Carton Barcode
VTFF250X110	250mm x 110mm	20		
VTFF260X200	260mm x 200mm	20		

For more info: [vuetrade.com/vtff](http://vuetrade.com/vtff)



### Flat Face Louvred Vents

Brick vents to reduce moisture in structures, ideal for fastening to the face of the wall with screws. **See Page 29**



Product Code	Size	Ctn Qty	Individual Barcode	Carton Barcode
VTFFLS230X160	230mm x 160mm	20		

For more info: [vuetrade.com/vtffls](http://vuetrade.com/vtffls)

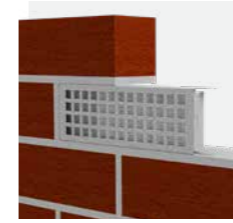

### Sub Floor Vents – Anti Spark

Brick vents fitted with fine stainless steel mesh, designed to combat sub floor moisture, ideal for areas which are prone to bushfire attack up to and including BAL-40. **See Page 28**



Product Code	Size	Ctn Qty	Individual Barcode	Carton Barcode
VTSFVAS230X76SLIM	230mm x 76mm - Slim	20		
VTSFVAS230X76	230mm x 76mm	20		
VTSFVAS190X190	190mm x 190mm	20		
VTSFVAS230X160	230mm x 160mm	20		
VTSFVAS390X190	390mm x 190mm	20		

For more info: [vuetrade.com/vtsfvas](http://vuetrade.com/vtsfvas) Also available in Stainless Steel. See page 98.

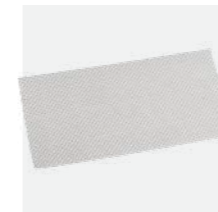

### Anti Spark Mesh – Stainless Steel

Wire mesh ideal for use with a vent to protect your home against embers and sparks from bushfires. **See Page 28**



Product Code	Size	Box Qty	Barcode
VTSSMESH	1220mm x 1.6mm Aperture x 0.9mm Wire	Per Square Metre	

For more info: [vuetrade.com/vtssmesh](http://vuetrade.com/vtssmesh)

# VUEBOLT

NOW AVAILABLE IN  
THREE MATERIAL FINISHES



BLACKOUT

ZINC-NICKEL COATED

316 STAINLESS STEEL

Scan here to see the full VUEBOLT range.



## Product Guide

### Zinc-Nickel Coated VUEBOLT - See Page 39

Product Code	Description	Ctn Qty	Individual Barcode	Carton Barcode
VUEBOLT90110	M10 x 90 - 110 mm Card of 2 (10.5mm Shaft)	6		
VUEBOLT90110HD	M12 x 90 - 110 mm Card of 2 (12.5mm Shaft)	6		
VUEBOLT110150	M12 x 110 - 150 mm Card of 2 (12.5mm Shaft)	6		
VUEBOLT110150HD	M16 x 110 - 150 mm Card of 2 (16.5mm Shaft)	6		
VUEBOLT150230	M16 x 150 - 230 mm Card of 2 (16.5mm Shaft)	6		
VUEBOLT230360	M20 x 230 - 360 mm Card of 1 (20.5mm Shaft)	6		

### 316 Stainless Steel VUEBOLT - See Page 39

Product Code	Description	Ctn Qty	Individual Barcode	Carton Barcode
VUEBOLT90110SS	M10 x 90 - 110 mm Card of 2 (10.5mm Shaft)	6		
VUEBOLT90110HDSS	M12 x 90 - 110 mm Card of 2 (12.5mm Shaft)	6		
VUEBOLT110150SS	M12 x 110 - 150 mm Card of 2 (12.5mm Shaft)	6		
VUEBOLT110150HDSS	M16 x 110 - 150 mm Card of 2 (16.5mm Shaft)	6		
VUEBOLT150230SS	M16 x 150 - 230 mm Card of 2 (16.5mm Shaft)	6		
VUEBOLT230360SS	M20 x 230 - 360 mm Card of 1 (20.5mm Shaft)	6		

### T50 Star Drive Wrench - See Page 38

Product Code	Pack Qty	Barcode
VTX50	2	

For more info: [vuetrade.com/vuebolt](http://vuetrade.com/vuebolt) Also available in BLACKOUT Powder Coated. See page 102.





### Stainless Steel Punched Builder's Strapping

Stainless steel tension bracing ideal for bracing roofs, walls, ceilings and floors in coastal areas.  
See Page 8



Product Code	Size	Carton Barcode
VB30815SS	30mm x 0.8mm x 15mt	9 341741 010042
VB30830SS	30mm x 0.8mm x 30mt	9 341741 010059
VB30115SS	30mm x 1.0mm x 15mt	9 341741 010066
VB30130SS	30mm x 1.0mm x 30mt	9 341741 010073

For more info: [vuetrade.com/vb-ss](http://vuetrade.com/vb-ss) Also available in Galvanised. See page 48.

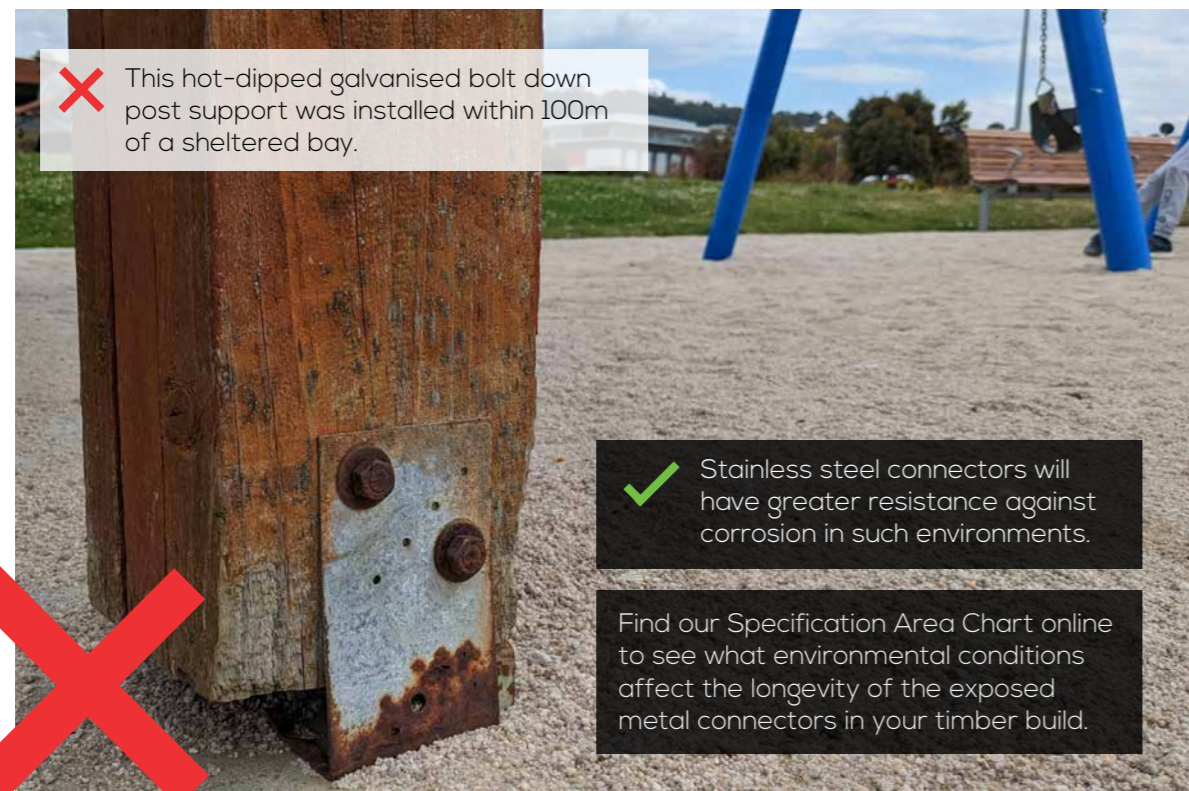

**X** This hot-dipped galvanized bolt down post support was installed within 100m of a sheltered bay.

**✓** Stainless steel connectors will have greater resistance against corrosion in such environments.

Find our Specification Area Chart online to see what environmental conditions affect the longevity of the exposed metal connectors in your timber build.

**Consider stainless steel for increased resistance against corrosion**

See our full Stainless Steel connectors range online: [vuetrade.com/products-ss](http://vuetrade.com/products-ss)

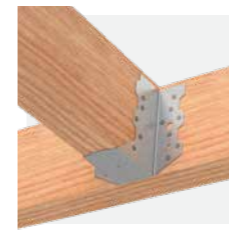

### Stainless Steel Joist Hangers

Time-saving, versatile hangers ideal for connecting joists to beams, trusses to beams, and roof trusses to girders in coastal areas.  
See Page 12



Product Code	Size	Ctn Qty	Individual Barcode	Carton Barcode
VJH3590SS	35mm x 90mm	45	9 341741 009466	9 341741 009640
VJH35120SS	35mm x 120mm	30	9 341741 009473	9 341741 009657
VJH35140SS	35mm x 140mm	30	9 341741 009480	9 341741 009664
VJH35180SS	35mm x 180mm	30	9 341741 009497	9 341741 009671
VJH4590SS	45mm x 90mm	45	9 341741 009541	9 341741 009725
VJH45120SS	45mm x 120mm	30	9 341741 009558	9 341741 009732
VJH45140SS	45mm x 140mm	30	9 341741 009565	9 341741 009749
VJH45180SS	45mm x 180mm	30	9 341741 009572	9 341741 009756
VJH45220SS	45mm x 220mm	20	9 341741 009589	9 341741 009763
VJH5090SS	50mm x 90mm	45	9 341741 009596	9 341741 009770
VJH50120SS	50mm x 120mm	30	9 341741 009602	9 341741 009787
VJH50140SS	50mm x 140mm	30	9 341741 009619	9 341741 009794
VJH50180SS	50mm x 180mm	30	9 341741 009626	9 341741 009800
VJH50220SS	50mm x 220mm	20	9 341741 009633	9 341741 009817

For more info: [vuetrade.com/vjh-ss](http://vuetrade.com/vjh-ss)

Also available in Galvanised. See page 51; or in BLACKOUT Powder Coated. See page 102.

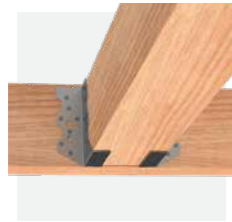

### Stainless Steel Split Joist Hangers

Fast fixing, multi-purpose hangers ideal for joist, beam and truss joining in coastal areas, with timber over the width of 50mm. **See Page 12**



Product Code	Size	Ctn Qty	Individual Barcode	Carton Barcode
VSJH120SS	120mm	30		
VSJH140SS	140mm	30		
VSJH180SS	180mm	30		
VSJH220SS	220mm	20		

For more info: [vuetrade.com/vsjh-ss](http://vuetrade.com/vsjh-ss) Also available in Galvanised. See page 52.



### Stainless Steel Triple Grips

Multipurpose Stainless Steel building brackets used in many nail-fixed timber joints with perpendicular angles, ideal for use on the coast. **See Page 14**



Product Code	Description	Ctn Qty	Individual Barcode	Carton Barcode
VTTGLHSS	LEFT HAND	100		
VTTGRHSS	RIGHT HAND	100		

For more info: [vuetrade.com/vttg-ss](http://vuetrade.com/vttg-ss) Also available in Galvanised. See page 54.



### Stainless Steel Mini Grips

Multipurpose timber framing brackets ideal for joining timber at right angles in coastal regions. **See Page 14**



Product Code	Size	Box Qty	Individual Barcode	Carton Barcode
VTMG57SS	57mm	200		

For more info: [vuetrade.com/vtmg57ss](http://vuetrade.com/vtmg57ss) Also available in Galvanised. See page 54.

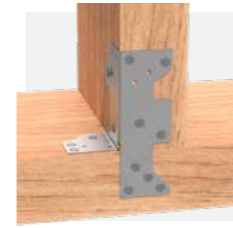

### Stainless Steel Multi Grips

Versatile, cost-effective brackets used for right angle joints in timber framing, ideal for coastal construction. **See Page 14**



Product Code	Size	Ctn Qty	Individual Barcode	Carton Barcode
VTMG100SS	100mm	200		

For more info: [vuetrade.com/vtmg-ss](http://vuetrade.com/vtmg-ss) Also available in Galvanised. See page 54.



### Stainless Steel Joist Straps

Easy to use connectors ideal for fixing ceiling joists or rafters to hanging beams. **See Page 13**



Product Code	Size	Ctn Qty	Individual Barcode	Carton Barcode
VTJS150SS	175mm LONG	150		

For more info: [vuetrade.com/vtjs-ss](http://vuetrade.com/vtjs-ss) Also available in Galvanised. See page 55.

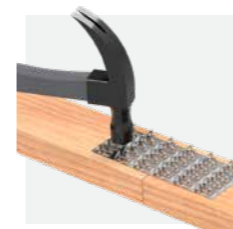

### Stainless Steel Tap In Plates

Timesaving nail plates with built-in steel 'teeth', ideal for joining timber wall frames and top plates in coastal areas. **See Page 17**



Product Code	Size	Ctn Qty	Individual Barcode	Carton Barcode
VTIP45120SS	45mm x 120mm	100		
VTIP45180SS	45mm x 180mm	67		
VTIP70120SS	70mm x 120mm	75		
VTIP70180SS	70mm x 180mm	50		

For more info: [vuetrade.com/vtip-ss](http://vuetrade.com/vtip-ss) Also available in Galvanised. See page 58.



### Stainless Steel Connector Plate Nails

316 Stainless Steel fixings specifically for fixing applications using any Stainless Steel VUETRADE timber connector. **See Page 16**



Product Code	Size	Ctn Qty	Barcode
VTCPNSS3028500	500g	6	
VTCPNSS30282	2kg	1	
VTCPNSS30285	5kg	1	

For more info: [vuetrade.com/vtcpnss](http://vuetrade.com/vtcpnss) Also available in Galvanised. See page 59.



### Stainless Steel Connector Plate Screws

Fixings designed to suit VUETRADE stainless steel timber connectors. **See Page 16**



Product Code	Description	Pack Qty	Carton Barcode
VTCPS35-100SS	5/16" HEX DRIVE x 35mm	100	
VTCPS35-250SS	5/16" HEX DRIVE x 35mm	250	
VTCPS65-100SS	5/16" HEX DRIVE x 65mm	100	
VTCPS65-250SS	5/16" HEX DRIVE x 65mm	250	

For more info: [vuetrade.com/vtcpss](http://vuetrade.com/vtcpss) Also available in Galvanised. See page 59.



### Stainless Steel Bearer Plates

Nail on plate suitable for timber connections, and repair and reinforcement of framing in coastal areas. **See Page 20**



Product Code	Size	Qty	Barcode
VTBP80120SS	80mm x 120mm	1	
VTBP80180SS	80mm x 180mm	1	
VTBP80240SS	80mm x 240mm	1	
VTBP80300SS	80mm x 300mm	1	

For more info: [vuetrade.com/vtbp-ss](http://vuetrade.com/vtbp-ss) Also available in Galvanised. See page 61.



### Stainless Steel Ultra Heavy Duty Angles

Multi-purpose right-angled brackets ideal for framing staircases. **See Page 21**



Product Code	Size	Ctn Qty	Individual Barcode	Carton Barcode
VTUHDA4040	40 x 40 x 230mm x 2.0mm	40		

For more info: [vuetrade.com/vtuhda](http://vuetrade.com/vtuhda)



### Stainless Steel Pergola Angles

Multi-purpose building brackets ideal for connecting pergola rafters to beams. **See Page 20**



Product Code	Size	Ctn Qty	Individual Barcode	Carton Barcode
VTPA36SS	92 x 68 x 36mm x 1.6mm	200		

For more info: [vuetrade.com/vtpa36ss](http://vuetrade.com/vtpa36ss)

Also available in Galvanised. See page 61; or in BLACKOUT Powder Coated. See page 102.



### Stainless Steel Hold Down Brackets

Heavy-duty brackets ideal for connecting wall studs and roof trusses in coastal areas.  
See Page 20



Product Code	Size	Ctn Qty	Individual Barcode	Carton Barcode
VTHDBSS	127 x 55 x 47mm x 2.0mm	75	9 341741 018550	9 341741 018567

For more info: [vuetrade.com/vthdbss](http://vuetrade.com/vthdbss)

Also available in Galvanised. See page 62; or in BLACKOUT Powder Coated. See page 102.



### Stainless Steel Angle Brackets - Heavy Duty

Stainless Steel multi-purpose right-angled brackets ideal for use on stairs and shelves.  
See Page 22



Product Code	Description	Size	Ctn Qty	Individual Barcode	Carton Barcode
VABHD02SS	40L x 60W x 100H x 3.0mm	M10	25	9 341741 021284	9 341741 021291
VABHD04SS	80L x 60W x 60H x 3.0mm	M10	25	9 341741 021307	9 341741 021314
VABHD05SS	80L x 60W x 100H x 3.0mm	M10	15	9 341741 021321	9 341741 021338
VABHD09SS	120L x 100W x 100H x 3.0mm	M10	10	9 341741 021345	9 341741 021352
VABHD12SS	160L x 100W x 100H x 3.0mm	M10	10	9 341741 021369	9 341741 021376

For more info: [vuetrade.com/vabhd-ss](http://vuetrade.com/vabhd-ss) Also available in Galvanised. See page 63.



### Stainless Steel Plates - Heavy Duty

Designed to allow connection between flat timber faces, ideal for areas of higher corrosion. See Page 22



Product Code	Description	Size	Ctn Qty	Individual Barcode	Carton Barcode
VPHD200120SS	200 x 120mm x 3.0mm	M10	10	9 341741 021505	9 341741 021512
VPHD20040SS	200 x 40mm x 3.0mm	M10	25	9 341741 021529	9 341741 021536
VPHD20080SS	200 x 80mm x 3.0mm	M10	15	9 341741 021543	9 341741 021550

For more info: [vuetrade.com/vphd-ss](http://vuetrade.com/vphd-ss) Also available in Galvanised. See page 66.



Consistent and effective carton design to suit every store size



Find your local stockist:  
[vuetrade.com/stockists](http://vuetrade.com/stockists)



**Stainless Steel Full Stirrup Post Supports**

U-saddle post anchors ideal for coastal areas, fixing timber posts by bolting onto or setting into concrete. **See Page 35**



Product Code	Size	Ctn Qty	Individual Barcode	Carton Barcode
VPS7590SS304*	75mm x 90mm	1		
VPS13090SS	130mm x 90mm	10		
VPS15090SS304*	150mm x 90mm	1		
VPS20090SS	200mm x 90mm	10		
VPS25090SS304*	250mm x 90mm	1		
VPS30090SS	300mm x 90mm	10		
VPS37590SS304*	375mm x 90mm	1		
VPS45090SS304*	450mm x 90mm	1		
VPS60090SS304*	600mm x 90mm	1		
VPS75100SS304*	75mm x 100mm	1		
VPS130100SS304*	130mm x 100mm	1		
VPS150100SS304*	150mm x 100mm	1		
VPS200100SS304*	200mm x 100mm	1		
VPS250100SS304*	250mm x 100mm	1		
VPS300100SS304*	300mm x 100mm	1		
VPS375100SS304*	375mm x 100mm	1		
VPS450100SS304*	450mm x 100mm	1		
VPS600100SS304*	600mm x 100mm	1		

Also available in Galvanised. See page 68; or in BLACKOUT Powder Coated. See page 102.

\*Non-stocked lines. All available in SS316 by special order. For more info: [vuetrade.com/vps](http://vuetrade.com/vps)

**Full Stirrup Post Supports c'td**

Product Code	Size	Ctn Qty	Individual Barcode	Carton Barcode
VPS130115SS	130mm x 115mm	10		
VPS200115SS304*	200mm x 115mm	1		
VPS300115SS	300mm x 115mm	10		
VPS450115SS304*	450mm x 115mm	1		
VPS130125SS	130mm x 125mm	10		
VPS150125SS304*	150mm x 125mm	1		
VPS300125SS304*	300mm x 125mm	1		
VPS450125SS304*	450mm x 125mm	1		
VPS130135SS	130mm x 135mm	10		
VPS200135SS304*	200mm x 135mm	1		
VPS300135SS304*	300mm x 135mm	1		
VPS450135SS304*	450mm x 135mm	1		
VPS200140SS304*	200mm x 140mm	1		
VPS300140SS304*	300mm x 140mm	1		
VPS450140SS304*	450mm x 140mm	1		
VPS150150SS304*	150mm x 150mm	1		
VPS300150SS304*	300mm x 150mm	1		
VPS450150SS304*	450mm x 150mm	1		
VPS150200SS304*	150mm x 200mm	1		
VPS300200SS304*	300mm x 200mm	1		
VPS450200SS304*	450mm x 200mm	1		



### Stainless Steel Half Stirrup Post Support

Brackets ideal for coastal construction, fixing timber posts that can only be accessed from one side by bolting or inserting into concrete. **See Page 35**



Product Code	Size	Ctn Qty	Individual Barcode	Carton Barcode
VHSPS125SS	125mm	10		
VHSPS200SS304*	200mm	1		
VHSPS300SS304*	300mm	1		

For more info: [vuetrade.com/vhspss](http://vuetrade.com/vhspss) Also available in Galvanised. See page 70.

\*Non-stocked lines. All available in SS316 by special order.



### Stainless Steel Centre Blade Post Support

Brackets ideal for coastal construction, with the 'hidden' blade providing a neat finish at the base of a timber post. **See Page 33**



Product Code	Size	Ctn Qty	Individual Barcode	Carton Barcode
VBLPS125SS	125mm	10		
VBLPS300SS304*	300mm	1		

For more info: [vuetrade.com/vblpsss](http://vuetrade.com/vblpsss) Also available in Galvanised. See page 70.

\*Non-stocked lines. All available in SS316 by special order.

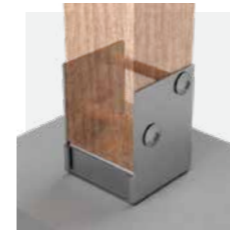

### 90mm Stainless Steel Bolt Down Post Support

Anchors ideal for bolting down timber posts in coastal areas, giving the choice of an open or concealed finish.



Product Code	Size	Ctn Qty	Individual Barcode	Carton Barcode
VBPS90SS	90mm	10		
VBPS90SS316	90mm	10		

For more info: [vuetrade.com/vbps90ss](http://vuetrade.com/vbps90ss)



### Stainless Steel Bolt Down Post Support

Anchors ideal for bolting down timber posts in coastal areas. **See Page 34**



Product Code	Size	Ctn Qty	Individual Barcode	Carton Barcode
VBPS100SS	100mm	10		
VBPS115SS	115mm	10		
VBPS125SS	125mm	10		
VBPS135SS	135mm	10		
VBPS140SS304*	140mm	1		
VBPS150SS304*	150mm	1		
VBPS200SS	200mm	10		

For more info: [vuetrade.com/vbpsss](http://vuetrade.com/vbpsss) Also available in Galvanised. See page 72.

\*Non-stocked lines. All available in SS316 by special order.



### Stainless Steel T-Blade Post Support

Brackets ideal for concealed, bolted fixing of feature timber posts on the coast. **See Page 32**



Product Code	Size	Ctn Qty	Individual Barcode	Carton Barcode
VBPTB90100SS	80 x 80mm Base - 250mm Blade	6		
VBPTB115140SS	110 x 110mm Base - 275mm Blade	6		
VBPTB150180SS	140 x 140mm Base - 300mm Blade	4		
VBPTB180200SS	180 x 180mm Base - 350mm Blade	2		
VBPTB250350SS	240 x 240mm Base - 400mm Blade	1		

Also available in Galvanised. See page 73; or in BLACKOUT Powder Coated. See page 102.

All available in SS316 by special order. For more info: [vuetrade.com/vbptb-ss](http://vuetrade.com/vbptb-ss)



### T-Blade Post Support Cap

316 grade stainless steel concealing caps to suit VUETRADE T-Blade Post Supports, covering base bolts for a neat finish on feature timber posts.



Product Code	Size	Ctn Qty	Individual Barcode	Carton Barcode
VBPTB90100CAP	90 x 90 x 30mm	6		
VBPTB115140CAP	120 x 120 x 30mm	6		
VBPTB150180CAP	150 x 150 x 30mm	4		
VBPTB180200CAP	190 x 190 x 30mm	2		
VBPTB250350CAP	250 x 250 x 30mm	1		N/A

For more info: [vuetrade.com/vbptb-cap](http://vuetrade.com/vbptb-cap) Also available in BLACKOUT Powder Coated. See page 102.



### Stainless Steel T-Blade Post Support With Leg

Concealed anchors ideal for coastal use, installed by bolting timber posts onto or setting them into concrete. **See Page 32**



Product Code	Size	Ctn Qty	Barcode
VHDBLPS60080SS	80 x 80mm Base - 250mm Blade, 600mm x 35mm Leg	1	
VHDBLPS600110SS	110 x 110mm Base - 275mm Blade, 600mm x 35mm Leg	1	
VHDBLPS600140SS	140 x 140mm Base - 300mm Blade, 600mm x 35mm Solid Leg	1	
VHDBLPS600180SS	180 x 180mm Base - 350mm Blade, 600mm x 73mm Leg	1	

For more info: [vuetrade.com/vhdblps-ss](http://vuetrade.com/vhdblps-ss) Also available in Galvanised. See page 72.

All available in SS316 by special order.



**The original and best T-Blade system for a clean, architectural finish**



Scan for T-Blade System info: [vuetrade.com/t-blade](http://vuetrade.com/t-blade)



### Stainless Steel Cyclonic Post Supports

U shaped anchors ideal for fixing timber posts in cyclonic or high wind areas on the coast. **See Page 35**

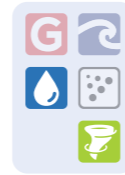

Product Code	Size	Ctn Qty	Individual Barcode	Carton Barcode
VCYPS30090SS304*	300mm x 90mm	1		
VCYPS45090SS	450mm x 90mm	6		
VCYPS60090SS	600mm x 90mm	6		
VCYPS300100SS304*	300mm x 100mm	1		
VCYPS450100SS	450mm x 100mm	6		
VCYPS600100SS	600mm x 100mm	6		
VCYPS450115SS304*	450mm x 115mm	1		
VCYPS600115SS304*	600mm x 115mm	1		
VCYPS450125SS304*	450mm x 125mm	1		
VCYPS600125SS304*	600mm x 125mm	1		
VCYPS450135SS304*	450mm x 135mm	1		
VCYPS600135SS304*	600mm x 135mm	1		
VCYPS450140SS304*	450mm x 140mm	1		
VCYPS600140SS304*	600mm x 140mm	1		
VCYPS450150SS304*	450mm x 150mm	1		
VCYPS600150SS304*	600mm x 150mm	1		
VCYPS450180SS304*	450mm x 180mm	1		
VCYPS600180SS304*	600mm x 180mm	1		
VCYPS450200SS304*	450mm x 200mm	1		
VCYPS600200SS304*	600mm x 200mm	1		

\*Non-stocked lines. All available in SS316 by special order. For more info: [vuetrade.com/vcyps-ss](http://vuetrade.com/vcyps-ss)

Page 99

Page 102



### Stainless Steel Brick Veneer Ties

Stainless steel masonry wall ties ideal for coastal areas, providing stability to brickwork by joining it to timber wall frames. **See Page 26**



Product Code	Description	Ctn Qty	Individual Barcode	Carton Barcode
VBTLDR3	Light Duty with Nails; SS304	150		
VBTMDR3	Medium Duty with Screws; SS304	150		
VBTLDR4	Light Duty with Nails; SS316	150		
VBTMDR4	Medium Duty with Screws; SS316	150		

For more info: [vuetrade.com/vbt-ss](http://vuetrade.com/vbt-ss) Also available in Galvanised. See page 75.

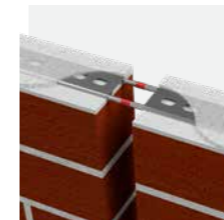

### Stainless Steel Double Sleeve Expansion Ties

Rod ties ideal for preventing masonry cracking in coastal areas. **See Page 27**



Product Code	Size	Box Qty	Individual Barcode	Carton Barcode
VTDSSS	285mm	50		

For more info: [vuetrade.com/vtdsss](http://vuetrade.com/vtdsss) Also available in Galvanised. See page 76.



### Stainless Steel Expansion Ties

Expansion gap ties designed for use in expansion joints to absorb lateral movement and stabilise masonry in coastal areas. **See Page 27**



Product Code	Box Qty	Individual Barcode	Carton Barcode
VTEXTSS	60		

For more info: [vuetrade.com/vtexts](http://vuetrade.com/vtexts) Also available in Galvanised. See page 76.

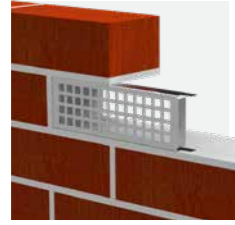

### Stainless Steel Sub Floor Vents

Brick vents designed to allow air movement in sub floors and prevent moisture damage on buildings. **See Page 28**



Product Code	Size	Ctn Qty	Individual Barcode	Carton Barcode
VTSFV230X76SS	230 x 76mm - PUNCHED GRID	20	9 341741 018901	9 341741 018918

For more info: [vuetrade.com/vtsfv-ss](http://vuetrade.com/vtsfv-ss)

Also available in Galvanised. See page 77; or in BLACKOUT Powder Coated. See page 102.



### Stainless Steel Sub Floor Vents Anti-Spark

Brick vents fitted with fine stainless steel mesh, designed to combat sub floor moisture, ideal for areas which are prone to bushfire attack up to and including BAL-40. **See Page 28**



Product Code	Size	Ctn Qty	Individual Barcode	Carton Barcode
VTSFVAS230X76SS	BAL40 - 230 x 76mm - PUNCHED GRID	20	9 341741 019007	9 341741 019014

For more info: [vuetrade.com/vtsfav-ss](http://vuetrade.com/vtsfav-ss) Also available in Galvanised. See page 79.



### Cyclonic Post Supports

U shaped anchors ideal for fixing timber posts in cyclonic or high wind areas. **See Page 35**



Product Code	Size	Ctn Qty	Individual Barcode	Carton Barcode
VCYPS60075	600mm x 75mm	6	9 341741 016013	9 341741 016020
VCYPS30090	300mm x 90mm	6	9 341741 006267	9 341741 006755
VCYPS45090	450mm x 90mm	6	9 341741 006281	9 341741 006779
VCYPS60090	600mm x 90mm	6	9 341741 007776	9 341741 007783
VCYPS300100	300mm x 100mm	6	9 341741 006250	9 341741 006748
VCYPS450100	450mm x 100mm	6	9 341741 006274	9 341741 006762
VCYPS600100	600mm x 100mm	6	9 341741 007790	9 341741 007806
VCYPS450115	450mm x 115mm	6	9 341741 014309	9 341741 014316
VCYPS600115	600mm x 115mm	6	9 341741 014347	9 341741 014354
VCYPS450125	450mm x 125mm	6	9 341741 014323	9 341741 014330
VCYPS600125	600mm x 125mm	6	9 341741 014361	9 341741 014378
VCYPS600140	600mm x 140mm	6	9 341741 014385	9 341741 014392
VCYPS450150	450mm x 150mm	6	9 341741 015535	9 341741 015528
VCYPS600150	600mm x 150mm	6	9 341741 014408	9 341741 014415

For more info: [vuetrade.com/vcyps](http://vuetrade.com/vcyps)

Also available in Stainless Steel. See page 96; or in BLACKOUT Powder Coated. See page 102.



### Heavy Duty U-Cup Bolt Down Post Support

Heavy duty anchors ideal for bolting timber posts to existing timber decking or concrete bases. **See Page 34**



Product Code	Size	Ctn Qty	Individual Barcode	Carton Barcode
VHDBPS75	75mm	10		
VHDBPS90	90mm	10		
VHDBPS100	100mm	10		
VHDBPS115	115mm	10		
VHDBPS125	125mm	10		
VHDBPS140	140mm	10		
VHDBPS150	150mm	10		

For more info: [vuetrade.com/vhdbps](http://vuetrade.com/vhdbps)



### T-Blade Post Support - Adjustable Leg

Strong, conveniently adjustable connectors ideal for fixing timber posts, by bolting onto or setting into concrete. **See Page 32**



Product Code	Size	Shaft Dia.	Ctn Qty	Barcode
VHDTRTB90100	80 x 80mm Base - 250mm BLADE - 10.0mm WALL	40mm	1	
VHDTRTB115140	110 x 110mm Base - 275mm BLADE - 10.0mm WALL	48mm	1	
VHDTRTB150180	140 x 140mm Base - 300mm BLADE - 10.0mm WALL	48mm	1	
VHDTRTB180200	180 x 180mm Base - 350mm BLADE - 10.0mm WALL	60mm	1	

For more info: [vuetrade.com/vhdtrtb](http://vuetrade.com/vhdtrtb)



### Double T-Blade Post Support

Strong support solutions ideal for fixing timber posts, by bolting onto concrete or cast into concrete. **See Page 33**



Product Code	Size	Ctn Qty	Barcode
VDTB150180	140 x 140mm Base - 150mm BLADE - 100mm LEG	1	
VDTB180200	180 x 180mm Base - 200mm BLADE - 150mm LEG	1	

For more info: [vuetrade.com/vdtb](http://vuetrade.com/vdtb)



### Finned Blade Stirrup

Used with direct installation into concrete while offering a concealed finish. **See Page 36**



Product Code	Size	Ctn Qty	Individual Barcode	Carton Barcode
VFTB40050	400mm x 50mm - 6.0mm WALL	10		
VFTB60065	600mm x 65mm - 8.0mm WALL	10		
VFTB60075	600mm x 75mm - 10.0mm WALL	10		

For more info: [vuetrade.com/vftb](http://vuetrade.com/vftb)



### L-Stirrup Post Support

Strong connectors ideal for fixing timber joists and stair stringers, setting into concrete. **See Page 36**



Product Code	Size	Ctn Qty	Barcode	Carton Barcode
VLSPS7585	75mm Leg - 85mm Blade	10		
VLSPS12585	125mm Leg - 85mm Blade	10		
VLSPS30085	300mm Leg - 85mm Blade	10		
VLSPS45085	450mm Leg - 85mm Blade	10		
VLSPS300140	300mm Leg - 140mm Blade	10		
VLSPS450140	450mm Leg - 140mm Blade	10		

For more info: [vuetrade.com/vlsp](http://vuetrade.com/vlsp)

# BLACKOUT

POWDER COATED RANGE

BLACKOUT



T-BLADE



T-BLADE CAP



FULL STIRRUP

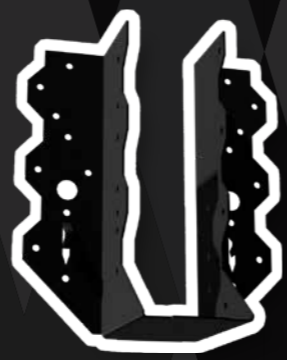

JOIST HANGER



BOLT DOWN



VUEBOLT

ULTRA HEAVY DUTY ANGLE

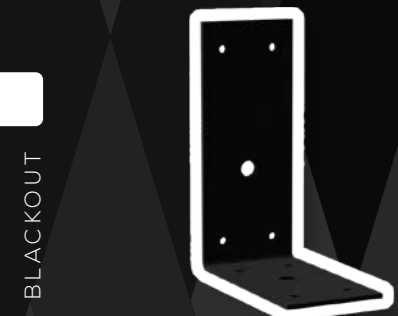

PERGOLA ANGLE

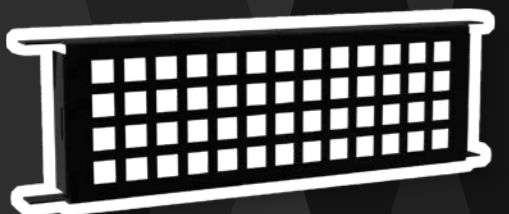

SUB FLOOR VENTS



HOLD DOWN BRACKET

Scan here to see the full BLACKOUT range.



POWDER COATED RANGE

BLACKOUT

Name	Product Code	Ctn Qty	Individual Barcode	Carton Barcode
<b>T-BLADE SYSTEM</b>				
80 x 80mm T-Blade	VBPTB90100BK	6	9 34 1741 023592	9 34 1741 023608
90 x 90mm Cap	VBPTB90100BKCAP	6	9 34 1741 024247	9 34 1741 024254
M12 x 90 - 110mm	VUEBOLT90110HDBK	Card of 2	9 34 1741 015870	N/A
110 x 110mm T-Blade	VBPTB115140BK	6	9 34 1741 023530	9 34 1741 023547
120 x 120mm Cap	VBPTB115140BKCAP	6	9 34 1741 024261	9 34 1741 024278
M16 x 110 - 150mm	VUEBOLT110150HDBK	Card of 2	9 34 1741 024322	N/A
140 x 140mm T-Blade	VBPTB150180BK	4	9 34 1741 023554	9 34 1741 023561
150 x 150mm Cap	VBPTB150180BKCAP	4	9 34 1741 024285	9 34 1741 024292
M16 x 150 - 230mm	VUEBOLT150230HDBK	Card of 2	9 34 1741 024346	N/A
<b>POST SUPPORTS</b>				
100mm Bolt Down	VBPS100BK	10	9 34 1741 023493	9 34 1741 023509
600 x 90mm Cyclonic	VCYPS60090BK	6	9 34 1741 023677	9 34 1741 023684
300 x 90mm Full Stirrup	VPS30090BK	10	9 34 1741 023950	9 34 1741 023967
90mm Tradies Bolt Down	VTBPS90BK	10	9 34 1741 023974	9 34 1741 023981
<b>FRAMING CONNECTORS</b>				
45 x 90mm Joist Hanger	VJH4590BK	20	9 34 1741 023813	9 34 1741 023820
45 x 140mm Joist Hanger	VJH45140BK	20	9 34 1741 023790	9 34 1741 023806
<b>BUILDING BRACKETS</b>				
92 x 68 x 36mm Pergola Angles	VTPA36BK	50	9 34 1741 024018	9 34 1741 024025
120 x 50 x 47mm Hold Down Bracket	VTHDBBK	50	9 34 1741 023998	9 34 1741 024001
230 x 40 x 40mm Ultra Heavy Duty Angles	VTUHDA4040BK	20	9 34 1741 024056	9 34 1741 024063
<b>MASONRY VENTS</b>				
230 x 76mm Sub Floor Vents	VTSFV230X76BK	20	9 34 1741 024032	9 34 1741 024049



GALVANISED



STAINLESS STEEL 304



STAINLESS STEEL 316



POWDER COATED



CYCLONIC RANGE



BOLT ONTO CONCRETE



CAST INTO CONCRETE



BAL-40

## PRODUCT GUIDE

BRACING & STRAPPING

FRAMING CONNECTORS

BUILDING BRACKETS

POST SUPPORTS

ANT CAPS

MASONRY TIES & VENTS

VUEBOLT

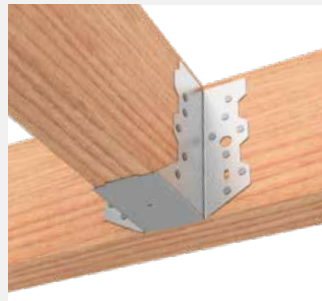

Other category documents:



1300 850 520

[www.vuetrade.com](http://www.vuetrade.com)

[customercare@bellevuegroup.com.au](mailto:customercare@bellevuegroup.com.au)